



Kährs



HARDWOOD, LVT, & HYBRID FLOORING

LOOK BOOK

1857

With a history that dates back to 1857, Kährs of Sweden is the oldest wood floor manufacturer in the world still in operation. For decades, Kährs has been a global leader with innovations that include the world's first patented engineered wood floor in 1941; the world's first water-based finishing system in 1984; and the first ISO 14001 environmental management certification in 1997.

Follow us on
social media to
learn more!



2022. Kährs introduces a new PVC-free, hybrid flooring called "AWARE"

1857. Kährs founded in the small town of Nybro, Sweden

1997. ISO 14001 Environmental management certification

2021. Kährs introduces a new generation of wood floors: Kährs Life

1984. Introduced first solvent-free finish

2000. Woodloc®, a world innovation - first glueless joint

1941. Invention of the multi-layer engineered wood floor

1958. The first factory-finished floor

2010. Woodloc® 5S, the next generation wood joint

QUALITY IN WOOD SINCE 1857

Wood is the most eco-friendly, beautiful and versatile flooring material there is. Few materials can add as much warmth and atmosphere as wood. It softens the most minimalistic designs, while accentuating the mood of a more traditional interior. While trends may come and go, quality and true style never go out of fashion. That's why a wood floor from Kährs will always be the perfect choice.

SEASONS GREETINGS



Compared to a traditional solid wood floor, our patented construction is 75% more stable. A Kährs floor resists warping, buckling and cracking, even as temperature and humidity change throughout the seasons. The construction creates a perfectly balanced wood floor that can tolerate even the most dramatic climate changes, making our wood floors the perfect partner for underfloor heating.

GAP FREE

When Kährs launched Woodloc® in 2000 – the first glue-free joint system in the world – it revolutionized the wood flooring industry. This ingenious joint system locks the boards together mechanically, creating a completely gap-free floor.



THE EASIEST INSTALLATION

Kährs floors are easy to install thanks to the ingenious Woodloc® joint. The boards lock together mechanically, with virtually invisible joints, providing perfect results, fast! The superior fit also enhances the floor's performance and durability.

MORE THAN A BEAUTIFUL SURFACE

Whichever surface treatment you choose for your Kährs floor, you can be sure that it will both enhance and protect the natural beauty of the wood. All Kährs surface treatments are naturally free from solvents, formaldehyde and isocyanate. They also make the floor really easy to clean and maintain.

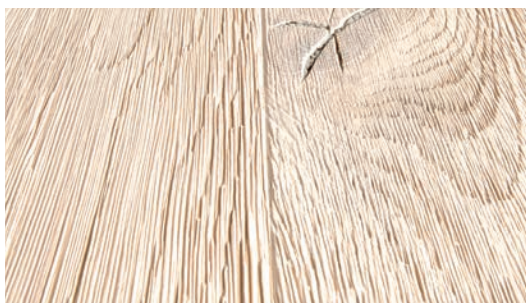

ENDLESS DESIGN VARIATIONS

Whatever the size of room or interior style, there's a Kährs floor that will enhance the space. Our wood floors come in many wood species, sizes, patterns and finishes.

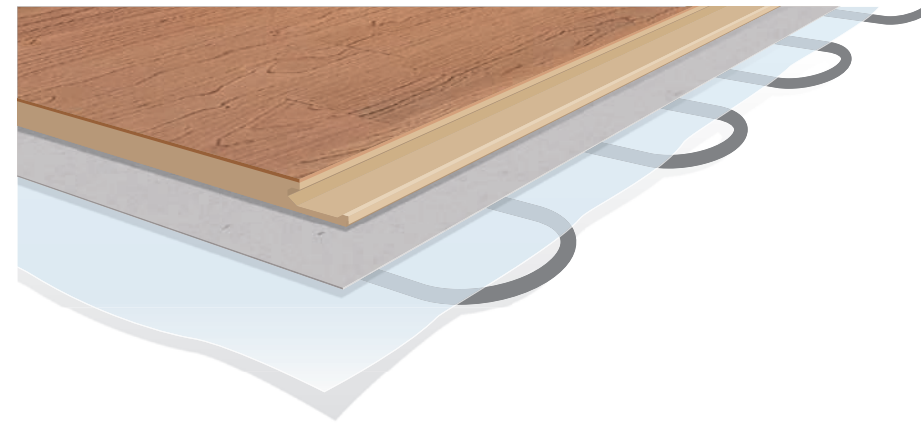

UNDERFLOOR HEATING

Kährs wood floors are ideally suited to underfloor heating. Please visit www.kahrs.com for detailed installation and operating instructions.



LEED

Many of Kährs products contribute to LEED (Leadership in Energy and Environmental Design) points on construction projects. To find out more, see our LEED Information sheet included in this book. If you have questions or would like further information, please contact your local Kährs representative or visit www.kahrs.com.

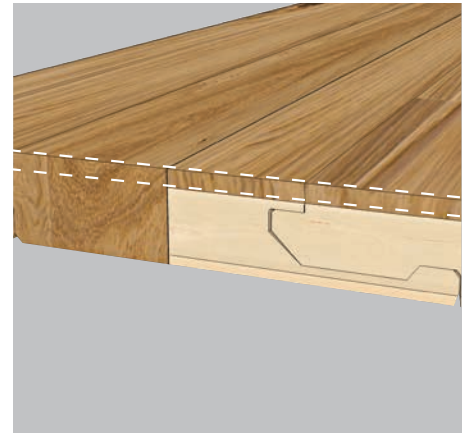

SANDS LIKE A SOLID

The Kährs multi-layer construction uses hardwood down to the joint with fast-growing timber below. It can be refurbished in exactly the same way as a solid floor.



THE FINISHING TOUCH

It's in the detail that you'll see the level of skill and craftsmanship that goes into every product made by Kährs. Choose from a wide range of moldings and accessories that are designed to add the perfect finishing touch.



DESIGNED WITH A CONSCIENCE

Choosing a wood floor is a great way of being environmentally responsible. By choosing a Kährs floor you are making a smarter, greener choice. Kährs is one of the oldest producers of wood flooring in the world – and the most innovative. During the last century, our many inventions have transformed the production of wood floors globally. Throughout this time we have continued to capture the beauty and expression of wood. We combine its natural character with cutting edge innovation to produce the highest quality wood flooring.

GREEN PRODUCT

The multi-layer wood floor that we invented in 1941 proved not only to be the best and most stable flooring on the market; it was also the most environmentally friendly construction. It optimizes the use of the raw material, is made from renewable resources, and is recyclable.



LESS RAW MATERIAL

Our multi-layered construction allows us to use the raw material more effectively, utilizing the whole log.



SOLVENT FREE

We constantly strive to find the most environmentally friendly, solvent-free stains and finishes. Also, our surfaces are easy to keep clean, without the need to use harsh chemicals.

GREEN PRODUCTION

Our production process is designed to have minimal impact on the environment. Over the years, Kährs has introduced a number of manufacturing and flooring innovations that have enabled a more responsible, green production. We work hard to reduce our impact on nature in terms of air quality, water discharge and noise control, to the benefit of our employees and neighbors.



HEALTHY PRODUCTION HEALTHY FLOOR

In 1984, Kährs was the first wood flooring manufacturer to utilize a water-based finishing system to reduce emissions. Kährs meets European E1, E0 and California Air Resources Board – Airborne Toxic Control Measure (CARB-ATCM) Phase 1 and 2 standards.



NOTHING IS WASTED

At our production plant in Nybro nothing goes to waste. The portion of the logs that we're not able to use for floor production are turned into biofuel. Some of this fuel is used to heat our own facilities. The rest goes to a local energy company. About 45,000 people in our neighborhood enjoy the warmth of our recycled wood.

A GREEN MINDSET

Environmental, Social, and Governance (ESG) and Corporate Social Responsibility (CSR) matters impact the communities where Kährs operates. We have made a public commitment to incorporate these ethical principles into the way we behave locally and globally.

Our commitment to the environment starts with the selection of the best raw material. This is achieved with the support of our 3000+ timber suppliers who share in our commitments.



PLANTING AHEAD

Kährs is working with local, national and global organizations to ensure the forest stock is sustainable for generations to come. In Sweden, the total forest volume is 60% larger today than it was in the 1920's. Kährs is working with leading global programs, reforestation programs and leading environmental groups to support globally responsible forestry.

ENVIRONMENTAL STANDARDS

Since the 1990's, Kährs' operations have been environmentally and quality certified. Many of Kährs' products contribute to LEED (Leadership in Energy and Environmental Design) points on construction projects.



KÄHRS PLANET POSITIVE JOURNEY



We have identified three major challenges that are highly relevant to our business:

-  **1. Climate Change**
-  **2. Resource Scarcity**
-  **3. Equality**

As a response to these challenges impacting Kährs' business, we have identified three corresponding focus areas to help us fulfill Kährs sustainability vision:

-  **Climate & Environmental Protection**
-  **Designed with a Conscience**
-  **Responsible Business**



- OUR COMMITMENTS**
- Reducing climate footprint
 - Net Zero Footprint by 2040
 - Transforming into a circular business
 - Regenerating resources & supporting biodiversity

- OUR COMMITMENTS**
- Creating a portfolio with sustainable floors
 - Promoting sustainable consumption

- OUR COMMITMENTS**
- Becoming a sustainable business across all stakeholders
 - Diversity and Inclusion Plan
 - Offering transparent information on our products

READ MORE AT WWW.KAHR.S.COM

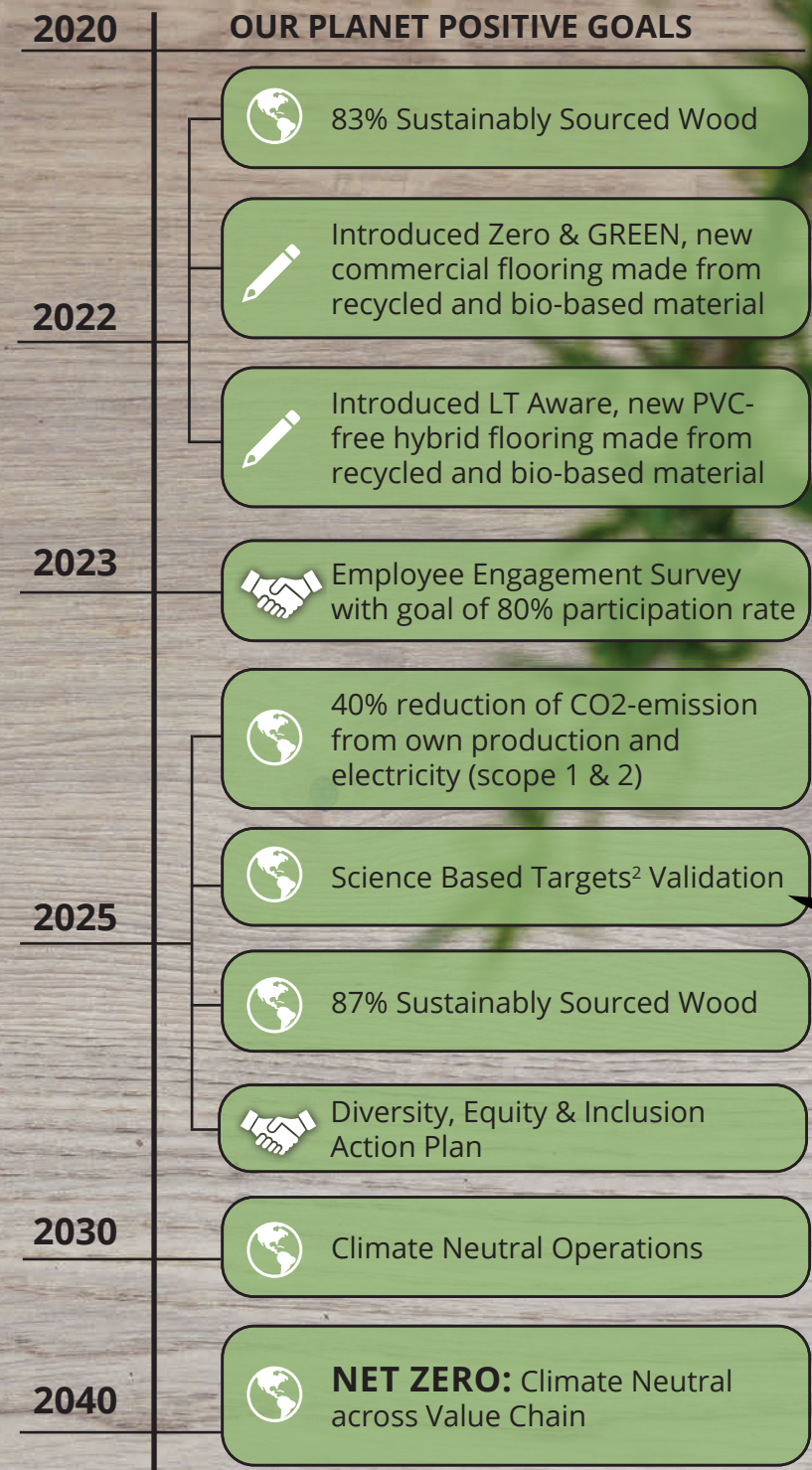

- MORE ABOUT OUR WOOD FLOORS**
- **100%** of our wood floors produced in Nybro are climate positive.
 - **200** of our wood floors have the Nordic Swan Ecolabel, the most respected and rigorous green label in the Nordics.
 - **140,000** tons of CO2 is yearly stored in installed wood floors from Kährs. This is equal to the amount of CO2 that 15,500 people consume every year.
 - **95%** of all the energy we are using in production is renewable.
 - **EPDs** are available for the majority of our wood product portfolio.

Kährs commits to calculate emissions according to an international recognized standard (SBT) and align with the Paris agreement to limit global warming by 1.5°C.



SCIENCE BASED TARGETS

Kährs is the 2nd flooring company to commit to Science Based Targets.¹

- MORE ABOUT OUR RESILIENT FLOORS**
- **100%** renewable energy used at our production site in Finland
 - **850 tons** of carbon footprint reduction thanks to renewable energy use
 - **EPDs/HPDs** available for all products
 - **First PVC-free homogeneous sheet** created by Upofloor (now Kährs) in 2014.

DID YOU KNOW?
WOOD IS A RENEWABLE RESOURCE & STORES CARBON DIOXIDE.

Our overarching vision to how we approach business. This vision includes regard for the climate, greenhouse gas emissions, ethics, justice, & human rights.

¹As of November 2021
²Read more at sciencebasedtargets.org

OUR PORTFOLIO

Today, Kährs wood and LVT floors can be seen in residential and commercial interiors all over the world. Fun fact: there is over 500 million square feet of Woodloc® flooring installed globally!



KÄHRS FLOOR PLANNER

Selecting a floor is one of the most important decisions in terms of interior design. To help consumers and architects in their buying decision, we've launched the new Kährs Floor Planner, a digital web-based room visualizer tool with state-of-the-art AI technology.

WHAT'S NEW IN THE UPDATED TOOL

- **AUTOMATIC FLOOR DETECTION FOR IMAGE UPLOADS**
State-of-the-art AI technology automatically detects the floor in uploaded images, making the visualization experience quick and user-friendly for everyone.
- **ENHANCED MOBILE EXPERIENCE: VISUALIZE ON THE GO!**
Pull up the Floor Planner on your mobile device, choose "upload image," and take a picture directly on your phone.
- **EASY DOWNLOAD FEATURE**
With one click, download your final image from the Floor Planner.



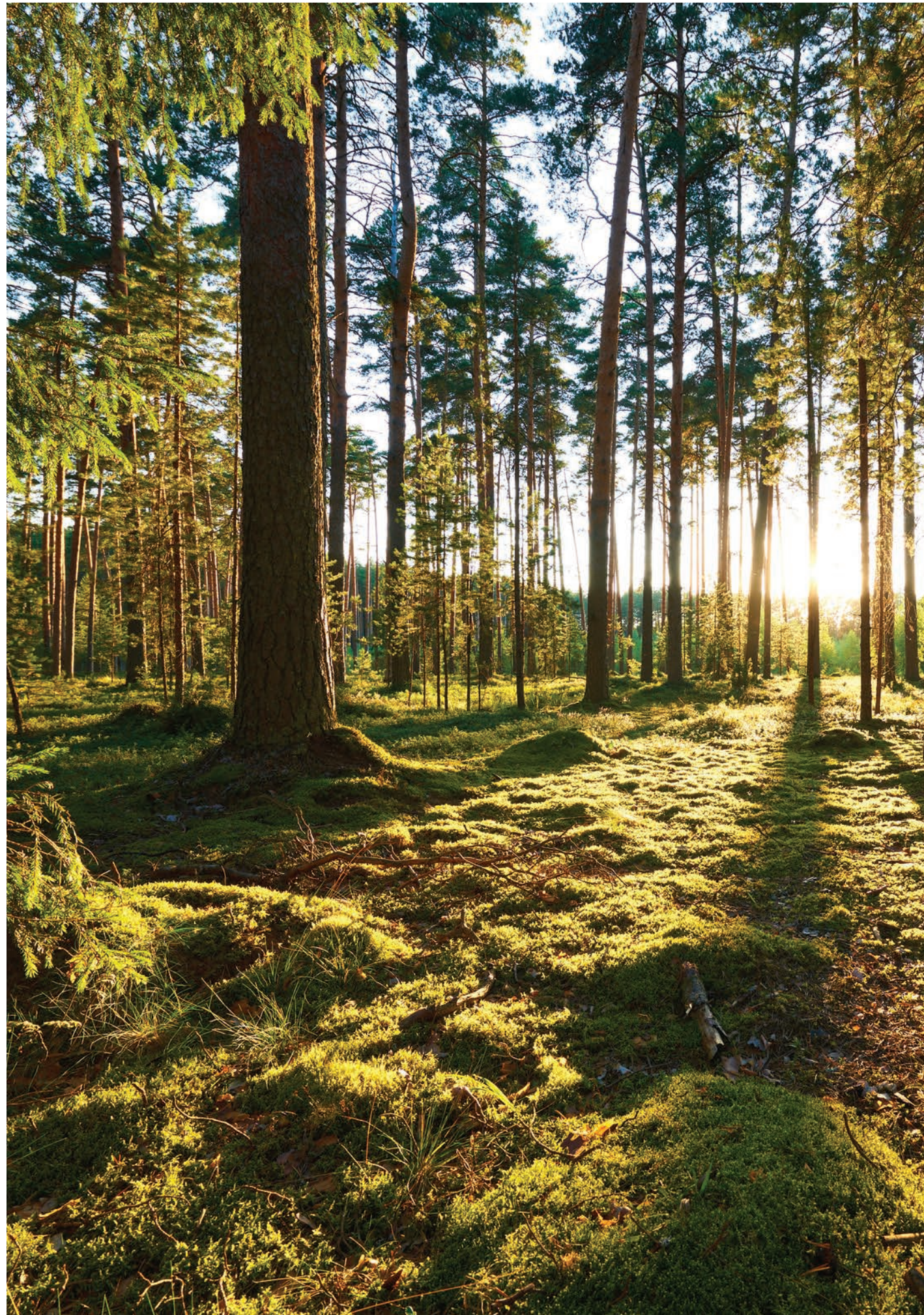

LEED INFORMATION

The **U.S. Green Building Council's LEED® green building program** is the preeminent program for the design, construction, maintenance and operations of high performance green buildings. Learn more at usgbc.org/LEED. Many of Kährs products contribute to **LEED (Leadership in Energy and Environmental Design) points** on construction projects. Please contact your local Kährs representative for the latest LEED information or visit www.kahrs.com.

KÄHR'S WOOD AND LT PRODUCTS - POTENTIAL LEED CONTRIBUTION

LEED v4 Building Design and Construction

MR | Building Product Disclosure: Environmental Product Declarations

EPD available for wood floors produced in Nybro, Sweden (Tres, Founders, Classic Nouveau, Beyond Retro, Texture, Lux, Capital, Harmony, Sand, European Renaissance, American Naturals, European Naturals, Scandinavian Naturals, World, Småland), EPD available for wood floors produced in Satalung, Romania (Ground Collection), EEPDs available for Click, Dry Back, and Loose Lay Luxury Tiles floors

MR | Building Product Disclosure and Optimization: Sourcing of Raw Material

Third-party verified corporate sustainability reports (CSR), which include environmental impacts of extraction operations and activities associated with the manufacturer's product and the product's supply chain, are valued as one whole product for credit achievement calculation.

FSC® certified products are available on demand via special request, subject to material availability.

This credit contains two options, with the second focused on "leadership extraction practices." To receive the credit, a project must use "at least 25%, by cost, of the total value of permanently installed building products." For wood products, the credit requires products "certified by the Forest Stewardship Council® or USGBC-approved equivalent."

Building Product Disclosure: Material Ingredients

FloorScore® Certification: Kährs Avanti, Kährs Canvas, Kährs Life, Kährs Original, Kährs Aware, Kährs LT Dry Back, Kährs LT Loose Lay, Kährs LT Click, Kährs QuietStride 2.0

IEQ | Low-Emitting Materials

Flooring - At least 90% of all flooring, by cost or surface area, must meet the VOC emissions evaluation or inherently non-emitting sources criteria.

Eco+ Underlayment - UL GreenGuard GOLD Certified

FloorScore® certified flooring products contribute to Low Emitting Material credits under the LEED v4 rating systems and other systems such as WELL, BREEAM, Green Globes, Collaborative for High Performance Schools (CHPS), California Section 01350, and other sustainable building requirements. Floors holding the FloorScore® logo are certified as contributing to indoor air quality. See above "Building Product Disclosure: Material Ingredients" section for Kährs products that hold a FloorScore® certification.



KÄHRS FLOORING GUIDE

Kährs offers a wide range of products with different finishes to meet the most diverse needs. All Kährs finishes are created by nature, engineered with the latest technology and produced with great respect for the environment.

SURFACE TREATMENT



- HIGH GLOSS FINISH**
 The high gloss finish gives your floor a shiny, polished look that enhances the beauty of the wood species you have chosen. High Gloss finish is durable and easy to maintain.
- SILK MATTE FINISH**
 Our silk matte finish complements the wood's character by emphasizing its natural structure. Making the floor durable and easy to clean, without concealing the woods natural luster.
- MATTE FINISH**
 Our matte finish creates the impression that the floor is made from untreated bare wood. The soft to touch natural surface is incredibly tactile and pleasing underfoot. Matte finish is durable and easy to maintain.
- NATURE OIL**
 Kährs oil finish reinforces the natural look and is incredibly tactile. The oil brings out the fine structure and grain of the timber yet adds depth to the natural wood tone. Kährs floors treated with oil are easy to maintain.
- ULTRA MATTE FINISH**
 Our ultra matte finish gives the look and feel of untreated, newly sawn timber. This innovative surface treatment is non-reflective, effectively enhancing the color of the floor while giving it a smooth, yet strong shield against wear and tear.

DESIGN FEATURES



- STAINED/SMOKED**
 Stains are used to further enhance the natural color tones of the wood – from the palest white and whisper greys to shades of rich mocha and charcoal. Some designs have also been smoked to enhance the color of the design.
- BRUSHED**
 Brushing the surface highlights the natural structure of the grain and accentuates the texture. Brushing is usually accompanied by other surface treatments, such as a beveled finish and a color stain or glaze.
- HANSCRAPED**
 Handscraping adds to the texture of a floor for a somewhat distressed and worn appearance typical of very rustic designs.
- BEVELED EDGES**
 Beveled edges add a touch of drama to a floor. Beveled styles vary from a micro-bevel – a slight accentuation of the edge using sandpaper – to a more dramatic, stronger bevel. In each style both long and short edges are beveled.

GRADING

Our grading system has been designed to make the product selection process easier and more visually driven through the introduction of five clearly distinguishable grades. Users will now be able to narrow down their product selection by grade to achieve a specific interior design theme.



- CALM**
 Minimalistic, clean and calm. The Calm grade floors are produced from our cleanest boards. They feature planks with a uniform appearance with small variation in grain and tone. They may contain small knots.
- VARIATION**
 Subtle character with variation. The Variation grade floors are characterized by subtle variation in color, tone and pattern. They may contain small knots.
- LIVELY**
 Lively and rustic character. Lively grade floors feature dramatic graining, gnarls and knots. They boast greater color variation and have a more lively and rustic character.
- DYNAMIC**
 Dynamic, warm and rustic character. Dynamic grade floors are made from boards with knots and cracks that give them a lively and dramatic, yet warm, character. They feature a broad variety of color tones.
- EXPRESSIVE**
 Bold and expressive statement. The Expressive grade floors are made from boards with dramatic cracks and powerful knots which also feature a wide variety of color tones.

DESIGN

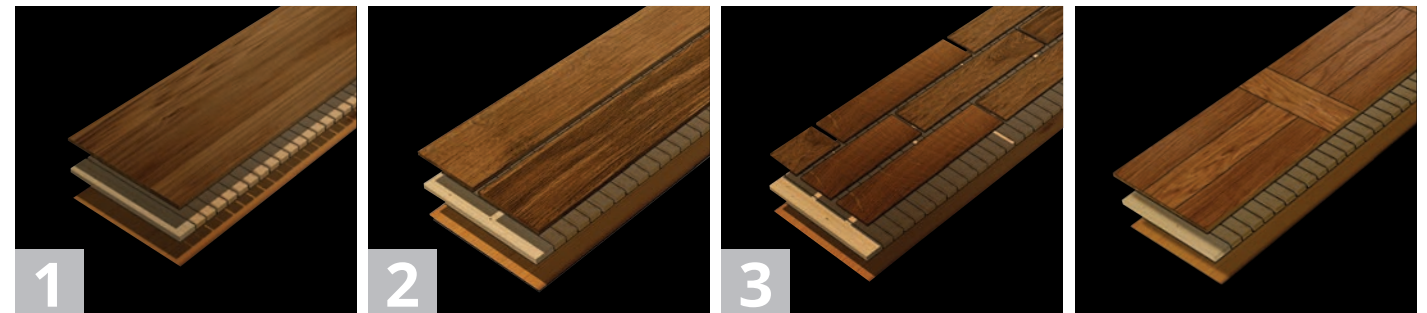

- 1-STRIP DESIGN**
 The surface of a 1-strip board is sawn in one piece. This emphasizes the natural beauty and accentuates every detail, from variations in color and grain, to individual knots.
- 2-STRIP DESIGN**
 The wear layer of this design is two strips wide. The strips are individually selected and arranged to give the floor its own unique character which complements all room styles.
- 3-STRIP DESIGN**
 With a wear layer that's 3-strips wide, these floors offer endless decorating opportunities and look particularly stunning in smaller spaces. Creating a linear effect, a 3-strip floor gives the illusion of a larger, more open space.
- PATTERNED DESIGNS**
 Dutch Pattern
 Chevron
 Combining traditional looks with modern styling.

EASY TO LOVE, HARD TO DAMAGE

The Kährs Life collection bridges the gap between high quality wood flooring and functional vinyl flooring. With a real wood veneer, stable HDF core, and a commercial finish, these floors are beautiful, functional, and made for everyday life.

A FINE COLLECTION OF FLOORING

With world renowned quality and flexibility, Kährs Avanti presents our most popular wood species and gradings paired with popular colors and styles.

THE FOUNDATION OF QUALITY

The Kährs Original range has grown into our largest and most popular line of wood floors. Available in a wide variety of wood species and finishes – and inspired by our Scandinavian roots – every floor is a true classic.

SUPREME QUALITY AND CRAFTSMANSHIP

Using time-honored skills, Kährs combines unrivaled hand-made craftsmanship, outstanding design, and the latest production and surface techniques to create floors of distinction. Floors in this collection come to life in an array of designs and finishes, all united by striking, exclusive looks and absolute attention to detail.

PVC-FREE, DURABLE FLOORING

The Aware Collection is a bio-based, natural, hybrid floor designed to withstand family-life and the wear and tear of commercial applications, all while offering the style, beauty, and feel of a wood floor.

DESIGNED TO LAST

Kährs Luxury Tiles are floors designed for everyday life. They offer the beautiful and natural appearance of wood and stone, while providing all the benefits, resilience, and easy maintenance of modern flooring technology.

Kährs Life

Kährs Avanti



Kährs Original

Kährs Supreme

NEW Kährs Aware

Kährs Luxury Tiles

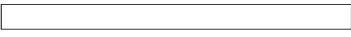

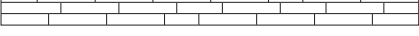
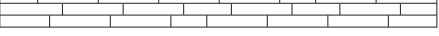

Kährs Life

Wide Plank	Life Collection		71 1/4" x 5 7/8" x 1/4"
Narrow Plank	Life Collection		48 1/4" x 4 5/8" x 1/4"
2-Strip	Life Collection		48 1/4" x 7 5/8" x 1/4"

Kährs Avanti

1 - Strip	Canvas Collection		73 1/4" x 5" x 1/2"
3 - Strip	Ground Collection		89 1/4" x 7 3/8" x 1/2"
3 - Strip	Tres Collection		95 3/8" x 7 7/8" x 1/2"

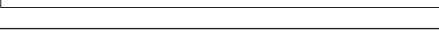
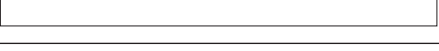
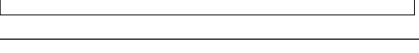
Kährs Original

Pattern	European Renaissance Collection		95 1/2" x 7 7/8" x 5/8"
3 - Strip	Beyond Retro, Scandinavian Naturals, European Naturals, American Naturals, Harmony, World Collections		95 3/8" x 7 7/8" x 5/8"
2 - Strip	European Naturals, Harmony, Sand Collections		95 3/8" x 7 7/8" x 5/8"
1 - Strip	Scandinavian Naturals		95 3/8" x 7 7/8" x 5/8"
1 - Strip	Scandinavian Naturals, Classic Nouveau, Founders, Lux, Texture, Capital Collections		95 1/4" x 7 3/8" x 5/8" Lux 6": 95 1/4" x 6" x 5/8"
1 - Strip	Classic Nouveau, Lux, Capital Collections		89 1/4" x 7 3/8" x 5/8" Lux 6": 89 1/4" x 6" x 5/8"
1 - Strip	Classic Nouveau, Lux, Capital, Beyond Retro Collections		78 3/4" x 7 3/8" x 5/8" Lux 6": 78 3/4" x 6" x 5/8"

Kährs Supreme

1 - Strip	Småland Collection		95 1/4" x 7 3/8" x 5/8"
-----------	--------------------	---	-------------------------

Kährs Aware PVC-Free Hybrid Flooring

Wood Design	Aware Collection		71 1/2" x 7 7/8" x 3/8"
-------------	------------------	---	-------------------------

Kährs Luxury Tiles - 5mm Click

Wood Look	5mm Click		47 5/8" x 6 3/4" x 5mm
Stone Look	5mm Click		23 5/8" x 11 3/4" x 5mm

Kährs Luxury Tiles - Impression Collection (6mm Click)

Wood Look	Impression 6mm Click		72" x 8 5/8" x 6mm
Stone Look	Impression 6mm Click		36" x 18" x 6mm

BOARD REFERENCE GUIDE

A benefit of Kährs hardwood floors is our long board lengths. The average height of a person in the U.S. is 5 foot 9 inches; most products, when stood on end, would be taller than the average person.



HOW TO USE THIS BINDER

- To navigate this book, use the chart below arranged by range and thickness, or the Table of Contents to the right. If you'd like to find a product based on color, on the next pages you are given a view of the Kährs products arranged by color range.
- To view information about a product, turn to the page indicated. On the product page, you will be able to see larger photos of the sample, interior photos, profile construction, board reference, and shipping specifications.
- To order a sample, visit <https://www.kahrs.com/en-us/order-samples/>.

THICKNESS	RANGE	COLLECTION
1/4" (7mm)	Kährs Life	• Kährs Life Collection 1
1/2" (13mm)	Kährs Avanti	• Tres Collection 23 • NEW Ground Collection 43 • Canvas Collection 57
5/8" (15mm)	Kährs Original	• Founders Collection 87 • Classic Nouveau Collection 99 • NEW Beyond Retro Collection 121 • Texture Collection 137 • Lux Collection 149 • Capital Collection 183 • Harmony Collection 195 • Sand Collection 211 • European Renaissance Collection 215 • American Naturals Collection 225 • European Naturals Collection 233 • Scandinavian Naturals Collection 237 • World Collection 241 • Småland Collection 243
1/4" (7mm)	Kährs Supreme	
1/4" (7mm)	Kährs Aware	• NEW PVC-Free Aware Collection 277
3/16" (5mm)	Kährs Luxury Tiles	• Click 5mm Wood Look 297 • Click 5mm Stone Look 325
1/4" (6mm)		• Click 6mm Impression Wood Look 333 • Click 6mm Impression Stone Look 353

LIFE COLLECTION

Coconut Cream	1
Light Suede	3
Pure Oak	5
Whole Grain	7
Driftwood	9
Earl Grey	11
Butterscotch	13
Faded Black	15
Pure Walnut	17
Cocoa Bean	19

TRES COLLECTION

Oak Supai	25
Oak Bisbee	27
Oak Pima	29
Oak Lecco	31
Red Oak Nature	33
Ash Ceriale	35
Ash Vaila	37
European Maple Gotha	39

NEW GROUND COLLECTION

Oak Clay	45
Oak Chalk	47
Oak Sand	49
Oak Seed	51
Ash Coral	53

CANVAS COLLECTION

Oak Curio	59
Oak Tuft	61
Oak Etch	63
Oak Tapa	65
Oak Carbon	67
Oak Morel (Special Order)	69
Oak Reiter	71
Oak Muse	73
Oak Cadence	75
Oak Mostra	77
Oak Fawn	79
Oak Henna	81
Oak Heather	83

FOUNDERS COLLECTION

Oak Gustaf	89
Oak Sture	91
Oak Fredrik	93
Oak Ulf	95

CLASSIC NOUVEAU COLLECTION

Oak Nouveau Gray	101
Oak Nouveau Black	103
Oak Nouveau Blonde	105
Oak Nouveau Greige	107
Oak Nouveau Lace	109
Oak Nouveau Snow	111
Oak Nouveau Taupe	113
Oak Nouveau Whisper	115
Oak Nouveau White	117

NEW BEYOND RETRO COLLECTION

Pearl Grey	123
Loft White	125
Urban Brown	127
Charcoal Light	129
Frosted Oat	131
Frozen Hazelnut	133

TEXTURE COLLECTION

Texture Grau	139
Texture Natur	141
Texture Rohoptic	143
Texture Weiss	145

LUX COLLECTION | 6" WIDE

Oak Ghost	151
Oak Eggshell	153
Oak Biscotti	155
Oak Crayon	157

LUX COLLECTION | SPECIAL ORDER

Ash Flow	161
Oak Aurora	163
Oak Coast	165
Oak Horizon	167
Oak Rise	169
Oak Shore	171
Oak Sky	173
Oak Sun	175
Oak Terra	177
Ash Stream	179

CAPITAL COLLECTION | SPECIAL ORDER

Oak Berlin	185
Oak Dublin	187
Oak Paris	189
Oak Prague	191

HARMONY COLLECTION

Oak Creme	197
Oak Granite	199
Oak Cirrus	201
Oak Lava	203
Oak Alloy	205
Oak Pale	207
Oak Limestone	209

SAND COLLECTION

Oak Portofino	211
---------------	-----

EUROPEAN RENAISSANCE COLLECTION

Oak Palazzo Fumo	217
Oak Palazzo Rovere	219
Oak Palazzo Bianco	221

AMERICAN NATURALS COLLECTION

Hard Maple Toronto	227
Cherry Savannah	229
Walnut Montreal	231

EUROPEAN NATURALS COLLECTION

Oak Siena	233
Oak Verona	235

SCANDINAVIAN NATURALS COLLECTION

Ash Gotland	237
Beech Viborg	239

WORLD COLLECTION

Brazilian Cherry La Paz	241
-------------------------	-----

SMÅLAND COLLECTION

Oak Vista	247
Oak Aspeland	249
Oak Möre	251
Oak Vedbo	253
Oak Finnveden	255
Oak Ydre	257
Oak Tvetta	259
Oak Sevede	261
Oak Handbörd	263
Oak Klinta	265

WOOD ACCESSORIES

Moldings & Transitions	269
Cleaning Supplies & Oils	272
Underlayments	274

NEW AWARE COLLECTION

Kappadokien	279
Bwindi	281
Grand Canyon	283
Yosemite	285
Serengeti	287
Yellowstone	289
Rocky	291
Smoky	293
Jasper	295

KÄHRS LUXURY TILES CLICK 5MM WOOD LOOK

Whinfell	301
Wentwood	303
Redwood	305
Yukon	307
Schwarzwald	309
Saxon	311
Oulanka	313
Belluno	315
Kannur	317
Niagara	319
Taiga	321
Sarek	323

KÄHRS LUXURY TILES CLICK 5MM STONE LOOK

Matterhorn	325
Steele	327
Makalu	329
Schwarzhorn	331

KÄHRS LUXURY TILES CLICK 6MM IMPRESSION WOOD LOOK

Dovecot	337
Spreewald	339
Balmoral	341
Foxall	343
Saham	345
Kelham	347
Odenwald	349
Laponia	351

KÄHRS LUXURY TILES CLICK 6MM IMPRESSION STONE LOOK

Ultar	353
Talung	355
Athos	357
Olympus	359
Amaro	361
Aneto	363
Grossglockner	365
Kilimanjaro	367

KÄHRS LT ACCESSORIES

LT Moldings & Transitions	371
---------------------------	-----



Please see pages 301-331 for the full Luxury Tile selection, including Click 5mm.

COCONUT CREAM

KÄHRS LIFE COLLECTION





COCOA BEAN WIDE PLANK

KÄHRS LIFE COLLECTION

The Life Collection features a range of wide plank, narrow plank, and 2-strip floors, in trendy colors ranging from light to dark. Made for everything from home installs to commercial use, these floors provide the best of both worlds: a beautiful hardwood floor with properties close to LVT - all at a cost-conscious price point.

- Innovative Lacquer
- Real Wood Layer
- Woodloc® 5G Joint
- High Quality HDF
- Real Wood Backing



COMMERCIAL FINISH



15 YEAR RESIDENTIAL WARRANTY
5 YEAR COMMERCIAL WARRANTY



WATERPROOF*



IMPACT SOUND REDUCTION

*Under conditions specified in the Kährs Life Warranty.



LIFE COLLECTION | COCONUT CREAM | WIDE PLANK



LIFE COLLECTION | COCONUT CREAM | NARROW PLANK



LIFE COLLECTION | COCONUT CREAM | 2-STRIP

LIFE COLLECTION

- Design:** Wide Plank, Narrow Plank, & Strip Options
- Features:** Oak; Stained; Micro Beveled Edges on Plank Designs; Square Edges on 2-Strip Designs
- Surface Treatment:** Commercial Grade Matte Finish (UV-Cured Acrylic)
- Wear Layer:** Approx. 0.6mm
- Grading:** Calm
- Joint:** Woodloc® 5G
- Guarantee:** 15 Year Residential
5 Year Commercial
- Installation:** Float, Glue-down

This product may be floated over radiant heat.

COCONUT CREAM

Wide Plank: LTCLRW3001-150
Narrow Plank: LTCLRW3001-118
**2-Strip: LTCLRW3001-193*

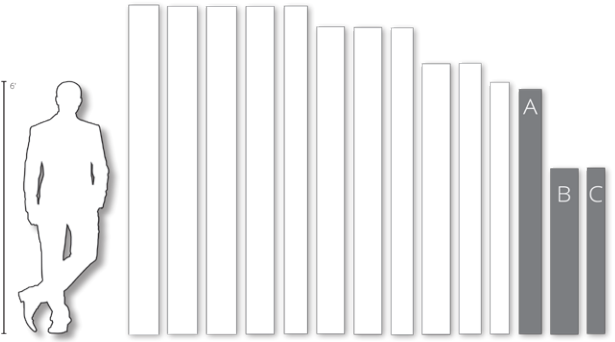

	Length	Width	Thickness	Boards/Ctn	Area	Weight	Ctn/Pallet	Pallets/Cont.
A. Wide Plank	71 1/4"	5 7/8"	1/4"	12	35.069ft ²	44lbs	54	16
B. <i>*2-Strip</i>	48 1/4"	7 5/8"	1/4"	12	30.483ft ²	40lbs	40	24
C. Narrow Plank	48 1/4"	4 5/8"	1/4"	12	18.730ft ²	24lbs	60	28

**Special Order*



3-Layer Construction:
High-grade veneer surface layer. | HDF middle layer. | Wood veneer bottom layer.



WIDE PLANK 2



LIFE COLLECTION | LIGHT SUEDE | WIDE PLANK



LIFE COLLECTION | LIGHT SUEDE | NARROW PLANK



LIFE COLLECTION | LIGHT SUEDE | 2-STRIP

LIFE COLLECTION

- Design:** Wide Plank, Narrow Plank, & Strip Options
- Features:** Oak; Stained; Micro Beveled Edges on Plank Designs; Square Edges on 2-Strip Designs
- Surface Treatment:** Commercial Grade Matte Finish (UV-Cured Acrylic)
- Wear Layer:** Approx. 0.6mm
- Grading:** Calm
- Joint:** Woodloc® 5G
- Guarantee:** 15 Year Residential
5 Year Commercial
- Installation:** Float, Glue-down

This product may be floated over radiant heat.

LIGHT SUEDE

- Wide Plank: LTCLR3002-150
- *Narrow Plank: LTCLR3002-118
- *2-Strip: LTCLR3002-193

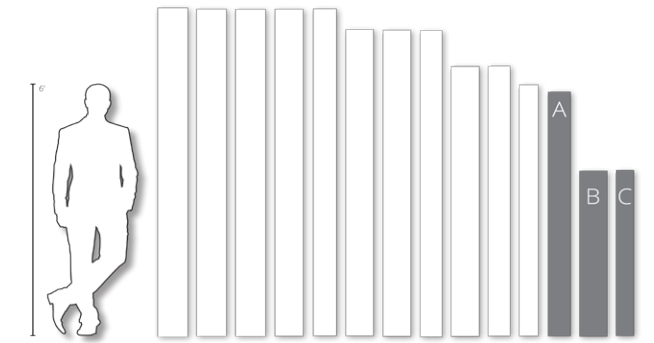

	Length	Width	Thickness	Boards/Ctn	Area	Weight	Ctn/Pallet	Pallets/Cont.
A. Wide Plank	71 1/4"	5 7/8"	1/4"	12	35.069ft ²	44lbs	54	16
B. *2-Strip	48 1/4"	7 5/8"	1/4"	12	30.483ft ²	40lbs	40	24
C. *Narrow Plank	48 1/4"	4 5/8"	1/4"	12	18.730ft ²	24lbs	60	28

**Special Order*

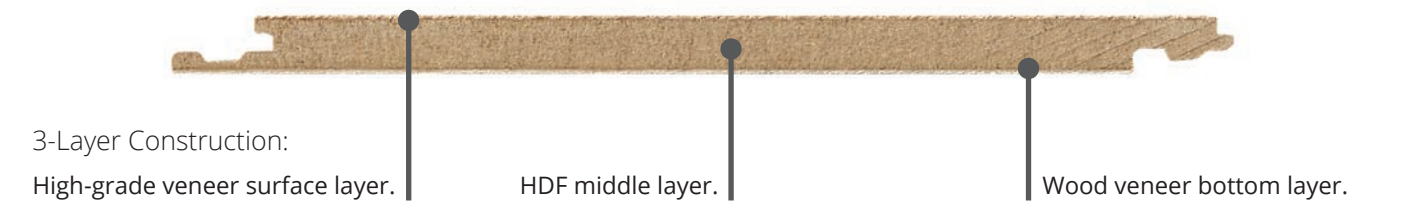

WIDE PLANK 4



LIFE COLLECTION | PURE OAK | WIDE PLANK



LIFE COLLECTION | PURE OAK | NARROW PLANK



LIFE COLLECTION | PURE OAK | 2-STRIP

LIFE COLLECTION

- Design:** Wide Plank, Narrow Plank, & Strip Options
- Features:** Oak; Micro Beveled Edges on Plank Designs; Square Edges on 2-Strip Designs
- Surface Treatment:** Commercial Grade Matte Finish (UV-Cured Acrylic)
- Wear Layer:** Approx. 0.6mm
- Grading:** Calm
- Joint:** Woodloc® 5G
- Guarantee:** 15 Year Residential
5 Year Commercial
- Installation:** Float, Glue-down

This product may be floated over radiant heat.

PURE OAK

Wide Plank: LTCLRW3003-150
Narrow Plank: LTCLRW3003-118
**2-Strip: LTCLRW3003-193*

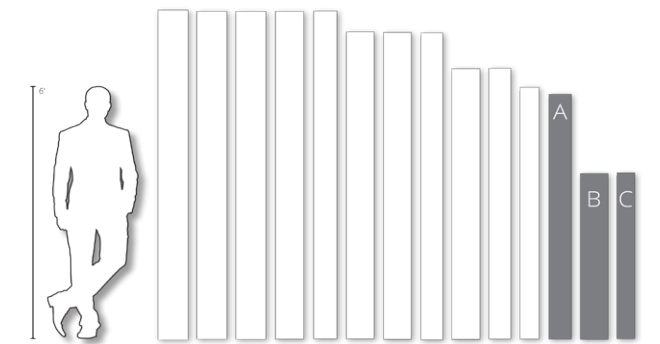

	Length	Width	Thickness	Boards/Ctn	Area	Weight	Ctn/Pallet	Pallets/Cont.
A. Wide Plank	71 1/4"	5 7/8"	1/4"	12	35.069ft ²	44lbs	54	16
B. <i>*2-Strip</i>	48 1/4"	7 5/8"	1/4"	12	30.483ft ²	40lbs	40	24
C. Narrow Plank	48 1/4"	4 5/8"	1/4"	12	18.730ft ²	24lbs	60	28

**Special Order*

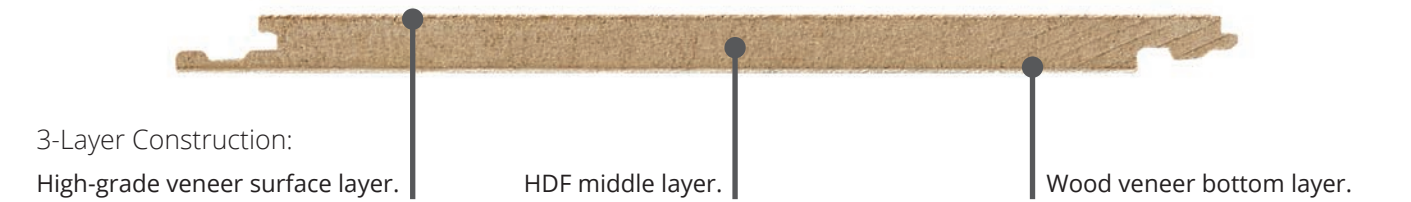

WIDE PLANK 6



LIFE COLLECTION | WHOLE GRAIN | WIDE PLANK



LIFE COLLECTION | WHOLE GRAIN | NARROW PLANK



LIFE COLLECTION | WHOLE GRAIN | 2-STRIP

LIFE COLLECTION

- Design:** Wide Plank, Narrow Plank, & Strip Options
- Features:** Oak; Stained; Micro Beveled Edges on Plank Designs; Square Edges on 2-Strip Designs
- Surface Treatment:** Commercial Grade Matte Finish (UV-Cured Acrylic)
- Wear Layer:** Approx. 0.6mm
- Grading:** Calm
- Joint:** Woodloc® 5G
- Guarantee:** 15 Year Residential
5 Year Commercial
- Installation:** Float, Glue-down

This product may be floated over radiant heat.

WHOLE GRAIN

Wide Plank: LTCLRW3004-150
Narrow Plank: LTCLRW3004-118
**2-Strip: LTCLRW3004-193*

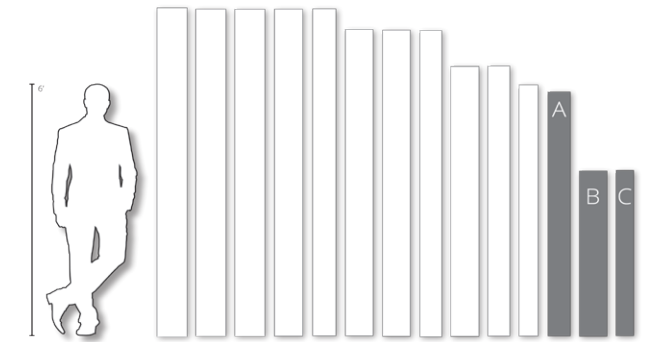

	Length	Width	Thickness	Boards/Ctn	Area	Weight	Ctn/Pallet	Pallets/Cont.
A. Wide Plank	71 1/4"	5 7/8"	1/4"	12	35.069ft ²	44lbs	54	16
B. <i>*2-Strip</i>	48 1/4"	7 5/8"	1/4"	12	30.483ft ²	40lbs	40	24
C. Narrow Plank	48 1/4"	4 5/8"	1/4"	12	18.730ft ²	24lbs	60	28

**Special Order*



3-Layer Construction:

High-grade veneer surface layer.

HDF middle layer.

Wood veneer bottom layer.



NARROW PLANK 8



LIFE COLLECTION | DRIFTWOOD | WIDE PLANK



LIFE COLLECTION | DRIFTWOOD | NARROW PLANK



LIFE COLLECTION | DRIFTWOOD | 2-STRIP

LIFE COLLECTION

- Design:** Wide Plank, Narrow Plank, & Strip Options
- Features:** Oak; Stained; Micro Beveled Edges on Plank Designs;
- Surface Treatment:** Commercial Grade Matte Finish (UV-Cured Acrylic)
- Wear Layer:** Approx. 0.6mm
- Grading:** Calm
- Joint:** Woodloc® 5G
- Guarantee:** 15 Year Residential
5 Year Commercial
- Installation:** Float, Glue-down

This product may be floated over radiant heat.

DRIFTWOOD

Wide Plank: LTCLR3005-150
Narrow Plank: LTCLR3005-118
**2-Strip: LTCLR3005-193*

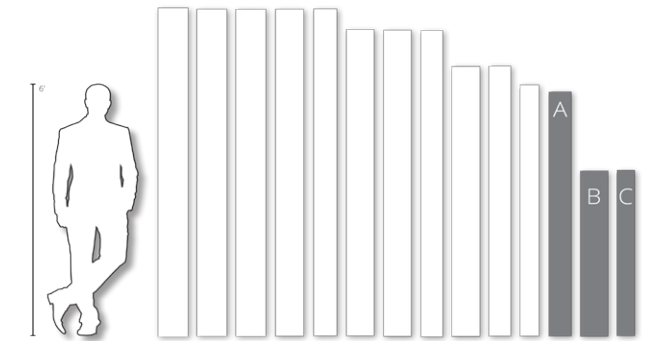

	Length	Width	Thickness	Boards/Ctn	Area	Weight	Ctn/Pallet	Pallets/Cont.
A. Wide Plank	71 1/4"	5 7/8"	1/4"	12	35.069ft ²	44lbs	54	16
B. <i>*2-Strip</i>	48 1/4"	7 5/8"	1/4"	12	30.483ft ²	40lbs	40	24
C. Narrow Plank	48 1/4"	4 5/8"	1/4"	12	18.730ft ²	24lbs	60	28

**Special Order*



3-Layer Construction:

High-grade veneer surface layer.

HDF middle layer.

Wood veneer bottom layer.



WIDE PLANK 10



LIFE COLLECTION | EARL GREY | WIDE PLANK



LIFE COLLECTION | EARL GREY | NARROW PLANK



LIFE COLLECTION | EARL GREY | 2-STRIP

LIFE COLLECTION

- Design:** Wide Plank, Narrow Plank, & Strip Options
- Features:** Oak; Stained; Micro Beveled Edges on Plank Designs; Square Edges on Strip Designs
- Surface Treatment:** Commercial Grade Matte Finish (UV-Cured Acrylic)
- Wear Layer:** Approx. 0.6mm
- Grading:** Calm
- Joint:** Woodloc® 5G
- Guarantee:** 15 Year Residential
5 Year Commercial
- Installation:** Float, Glue-down
This product may be floated over radiant heat.

EARL GREY

- Wide Plank: LTCLR3006-150
- *Narrow Plank: LTCLR3006-118
- *2-Strip: LTCLR3006-193

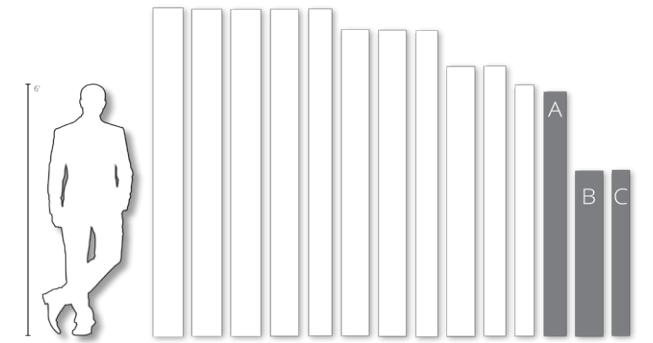

	Length	Width	Thickness	Boards/Ctn	Area	Weight	Ctn/Pallet	Pallets/Cont.
A. Wide Plank	71 1/4"	5 7/8"	1/4"	12	35.069ft ²	44lbs	54	16
B. *2-Strip	48 1/4"	7 5/8"	1/4"	12	30.483ft ²	40lbs	40	24
C. *Narrow Plank	48 1/4"	4 5/8"	1/4"	12	18.730ft ²	24lbs	60	28

*Special Order



3-Layer Construction:

High-grade veneer surface layer.

HDF middle layer.

Wood veneer bottom layer.



WIDE PLANK 12



LIFE COLLECTION | BUTTERSCOTCH | WIDE PLANK



LIFE COLLECTION | BUTTERSCOTCH | NARROW PLANK



LIFE COLLECTION | BUTTERSCOTCH | 2-STRIP

LIFE COLLECTION

- Design:** Wide Plank, Narrow Plank, & Strip Options
- Features:** Oak; Stained; Micro Beveled Edges on Plank Designs; Square Edges on 2-Strip Designs
- Surface Treatment:** Commercial Grade Matte Finish (UV-Cured Acrylic)
- Wear Layer:** Approx. 0.6mm
- Grading:** Calm
- Joint:** Woodloc® 5G
- Guarantee:** 15 Year Residential
5 Year Commercial
- Installation:** Float, Glue-down

This product may be floated over radiant heat.

BUTTERSCOTCH

- Wide Plank: LTCLR3007-150
- *Narrow Plank: LTCLR3007-118
- *2-Strip: LTCLR3007-193

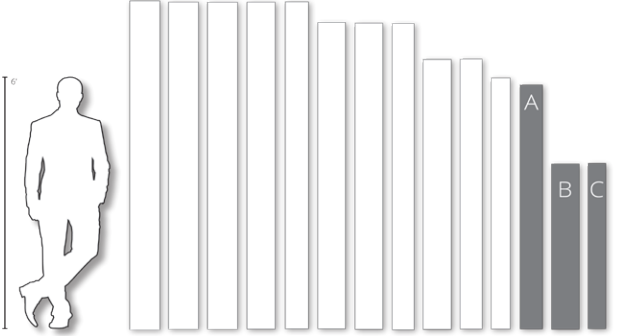

	Length	Width	Thickness	Boards/Ctn	Area	Weight	Ctn/Pallet	Pallets/Cont.
A. Wide Plank	71 1/4"	5 7/8"	1/4"	12	35.069ft ²	44lbs	54	16
B. *2-Strip	48 1/4"	7 5/8"	1/4"	12	30.483ft ²	40lbs	40	24
C. *Narrow Plank	48 1/4"	4 5/8"	1/4"	12	18.730ft ²	24lbs	60	28

**Special Order*



3-Layer Construction:
 High-grade veneer surface layer. HDF middle layer. Wood veneer bottom layer.



NARROW PLANK 14



LIFE COLLECTION | FADED BLACK | WIDE PLANK



LIFE COLLECTION | FADED BLACK | NARROW PLANK



LIFE COLLECTION | FADED BLACK | 2-STRIP

LIFE COLLECTION

- Design:** Wide Plank, Narrow Plank, & Strip Options
- Features:** Oak; Stained; Micro Beveled Edges on Plank Designs; Square Edges on 2-Strip Designs
- Surface Treatment:** Commercial Grade Matte Finish (UV-Cured Acrylic)
- Wear Layer:** Approx. 0.6mm
- Grading:** Calm
- Joint:** Woodloc® 5G
- Guarantee:** 15 Year Residential
5 Year Commercial
- Installation:** Float, Glue-down

This product may be floated over radiant heat.

FADED BLACK

- Wide Plank: LTCLRW3008-150
- *Narrow Plank: LTCLRW3008-118
- *2-Strip: LTCLRW3008-193

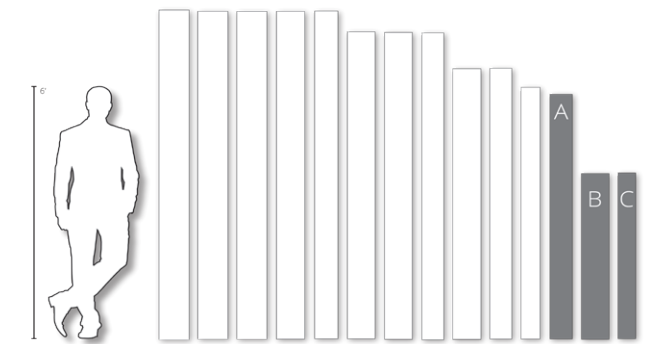

	Length	Width	Thickness	Boards/Ctn	Area	Weight	Ctn/Pallet	Pallets/Cont.
A. Wide Plank	71 1/4"	5 7/8"	1/4"	12	35.069ft ²	44lbs	54	16
B. *2-Strip	48 1/4"	7 5/8"	1/4"	12	30.483ft ²	40lbs	40	24
C. *Narrow Plank	48 1/4"	4 5/8"	1/4"	12	18.730ft ²	24lbs	60	28

**Special Order*



3-Layer Construction:

High-grade veneer surface layer.

HDF middle layer.

Wood veneer bottom layer.



WIDE PLANK 16



LIFE COLLECTION | PURE WALNUT | WIDE PLANK

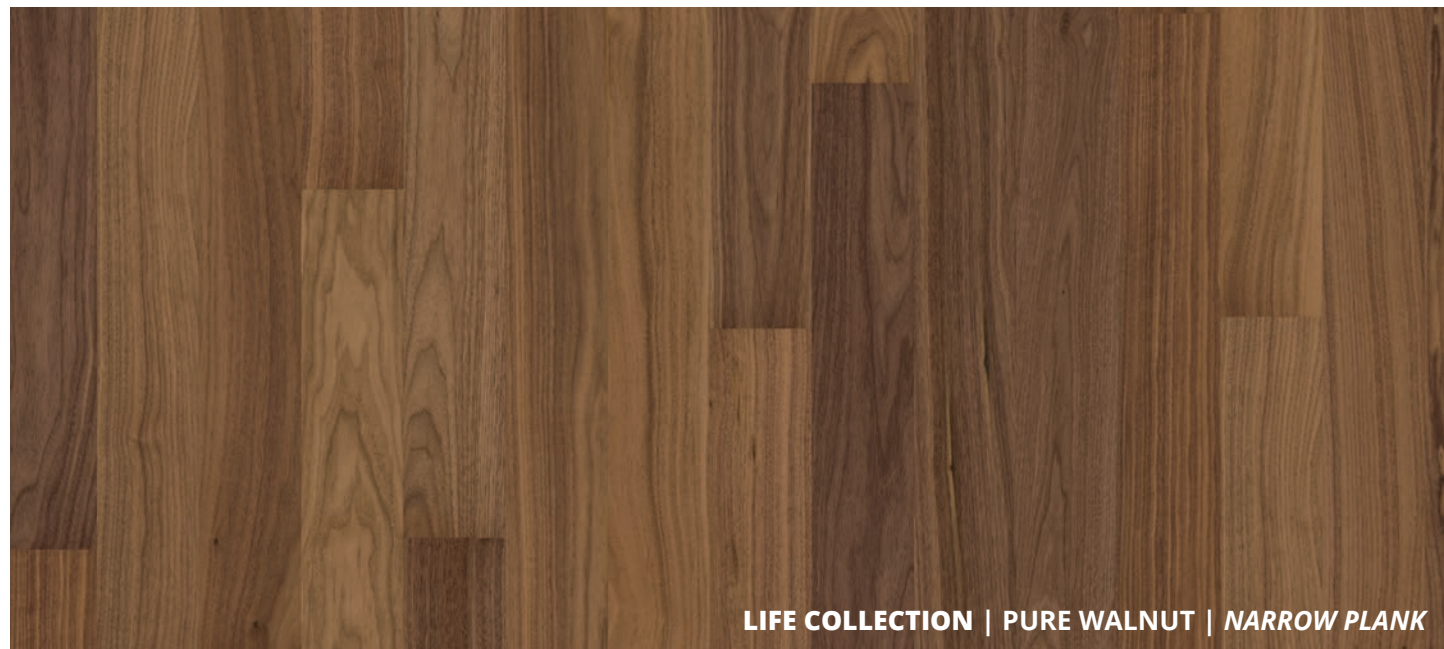

LIFE COLLECTION | PURE WALNUT | NARROW PLANK



LIFE COLLECTION | PURE WALNUT | 2-STRIP

LIFE COLLECTION

- Design:** Wide Plank, Narrow Plank, & Strip Options
- Features:** Walnut; Micro Beveled Edges on Plank Designs
- Surface Treatment:** Commercial Grade Matte Finish (UV-Cured Acrylic)
- Wear Layer:** Approx. 0.6mm
- Grading:** Calm
- Joint:** Woodloc® 5G
- Guarantee:** 15 Year Residential
5 Year Commercial
- Installation:** Float, Glue-down

This product may be floated over radiant heat.

PURE WALNUT

Wide Plank: LTCLRW3010-150
Narrow Plank: LTCLRW3010-118
**2-Strip: LTCLRW3010-193*

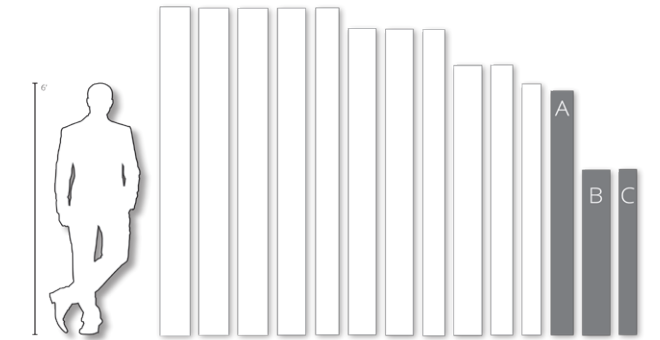

	Length	Width	Thickness	Boards/Ctn	Area	Weight	Ctn/Pallet	Pallets/Cont.
A. Wide Plank	71 1/4"	5 7/8"	1/4"	12	35.069ft ²	44lbs	54	16
B. <i>*2-Strip</i>	48 1/4"	7 5/8"	1/4"	12	30.483ft ²	40lbs	40	24
C. Narrow Plank	48 1/4"	4 5/8"	1/4"	12	18.730ft ²	24lbs	60	28

**Special Order*



3-Layer Construction:

High-grade veneer surface layer.

HDF middle layer.

Wood veneer bottom layer.



WIDE PLANK 18



LIFE COLLECTION | COCOA BEAN | WIDE PLANK



LIFE COLLECTION | COCOA BEAN | NARROW PLANK



LIFE COLLECTION | COCOA BEAN | 2-STRIP

LIFE COLLECTION

- Design:** Wide Plank, Narrow Plank, & Strip Options
- Features:** Oak; Stained; Micro Beveled Edges on Plank Designs; Square Edges on 2-Strip Designs
- Surface Treatment:** Commercial Grade Matte Finish (UV-Cured Acrylic)
- Wear Layer:** Approx. 0.6mm
- Grading:** Calm
- Joint:** Woodloc® 5G
- Guarantee:** 15 Year Residential
5 Year Commercial
- Installation:** Float, Glue-down

This product may be floated over radiant heat.

COCOA BEAN

- Wide Plank: LTCLRW3011-150
- *Narrow Plank: LTCLRW3011-118
- *2-Strip: LTCLRW3011-193

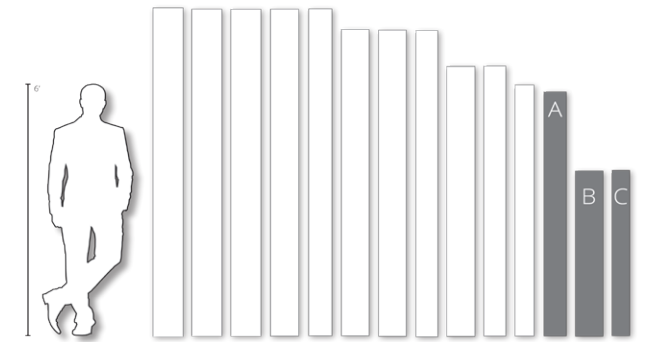

	Length	Width	Thickness	Boards/Ctn	Area	Weight	Ctn/Pallet	Pallets/Cont.
A. Wide Plank	71 1/4"	5 7/8"	1/4"	12	35.069ft ²	44lbs	54	16
B. *2-Strip	48 1/4"	7 5/8"	1/4"	12	30.483ft ²	40lbs	40	24
C. *Narrow Plank	48 1/4"	4 5/8"	1/4"	12	18.730ft ²	24lbs	60	28

**Special Order*



3-Layer Construction:

High-grade veneer surface layer.

HDF middle layer.

Wood veneer bottom layer.



WIDE PLANK 20



ASH CERIALE

TRES
COLLECTION



OAK LECCO

TRES COLLECTION

A traditional strip look with superior Kährs quality, in a myriad of colors, with both Oak and Ash options.

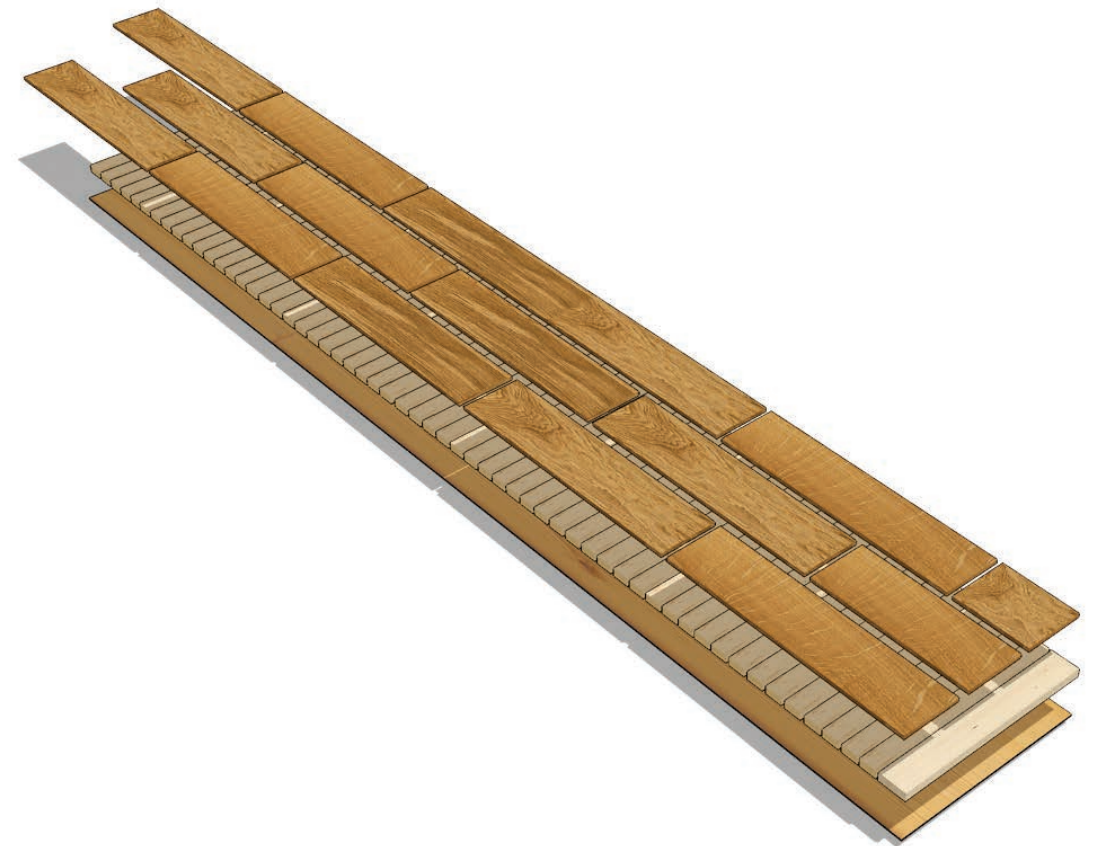



TRES COLLECTION

OAK SUPAI

133NABEK5LUW 0

- Design:** 3-Strip
 - Features:** European Oak, Stained, Square Edge, Smooth
 - Surface Treatment:** Silk Matte Finish (UV-Cured Acrylic)
 - Wear Layer:** Approx. 2.5mm
 - Grading:** Variation
 - Joint:** Woodloc® 5G
 - Guarantee:** Lifetime Structural
25 Year Wear Through
 - Installation:** Float, Glue-down, Nail-down
- This product may be floated over radiant heat.*

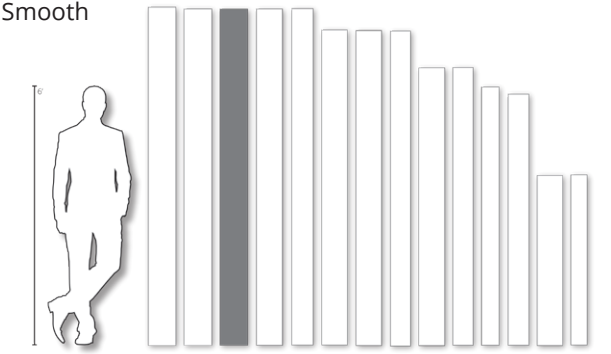

Length	Width	Thickness	Boards/Ctn	Area	Weight	Ctn/Pallet	Pallets/Cont.
95 3/8"	7 7/8"	1/2"	7	36.598ft²	54lbs	50	16



3-Layer Construction:
 Surface layer consists of sawn strips. Solid pine fingers. Bottom layer of Spruce veneer.





TRES COLLECTION

OAK BISBEE

133NABEK5MUW 0

- Design:** 3-Strip
 - Features:** European Oak, Stained, Square Edge, Smooth
 - Surface Treatment:** Silk Matte Finish (UV-Cured Acrylic)
 - Wear Layer:** Approx. 2.5mm
 - Grading:** Variation
 - Joint:** Woodloc® 5G
 - Guarantee:** Lifetime Structural
25 Year Wear Through
 - Installation:** Float, Glue-down, Nail-down
- This product may be floated over radiant heat.*

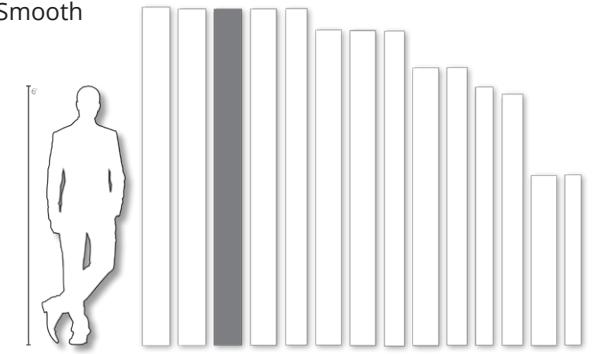

Length	Width	Thickness	Boards/Ctn	Area	Weight	Ctn/Pallet	Pallets/Cont.
95 3/8"	7 7/8"	1/2"	7	36.598ft ²	54lbs	50	16





TRES COLLECTION

OAK PIMA

133NABEK7CUW 0

- Design:** 3-Strip
 - Features:** European Oak, Stained, Square Edges, Smooth
 - Surface Treatment:** Gloss Finish (UV-Cured Acrylic)
 - Wear Layer:** Approx. 2.5mm
 - Grading:** Variation
 - Joint:** Woodloc® 5G
 - Guarantee:** Lifetime Structural
25 Year Wear Through
 - Installation:** Float, Glue-down, Nail-down
- This product may be floated over radiant heat.*

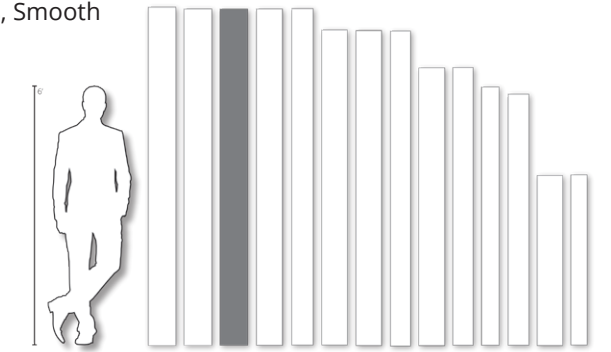

Length	Width	Thickness	Boards/Ctn	Area	Weight	Ctn/Pallet	Pallets/Cont.
95 3/8"	7 7/8"	1/2"	7	36.598ft²	54lbs	50	16



3-Layer Construction:

Surface layer consists of sawn strips.

Solid pine fingers.

Bottom layer of Spruce veneer.





TRES COLLECTION

OAK LECCO

133NABEK50KW 0

- Design:** 3-Strip
 - Features:** European Oak, Square Edges, Smooth
 - Surface Treatment:** Silk Matte Finish (UV-Cured Acrylic)
 - Wear Layer:** Approx. 2.5mm
 - Grading:** Variation
 - Joint:** Woodloc® 5G
 - Guarantee:** Lifetime Structural
25 Year Wear Through
 - Installation:** Float, Glue-down, Nail-down
- This product may be floated over radiant heat.*

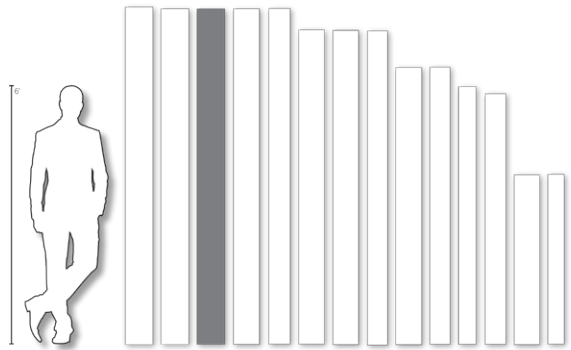

Length	Width	Thickness	Boards/Ctn	Area	Weight	Ctn/Pallet	Pallets/Cont.
95 3/8"	7 7/8"	1/2"	7	36.598ft²	54lbs	50	16





TRES COLLECTION

RED OAK NATURE

133NACER50KW 0

- Design:** 3-Strip
 - Features:** Red Oak, Square Edges, Smooth
 - Surface Treatment:** Silk Matte Finish (UV-Cured Acrylic)
 - Wear Layer:** Approx. 2.5mm
 - Grading:** Variation
 - Joint:** Woodloc® 5G
 - Guarantee:** Lifetime Structural
25 Year Wear Through
 - Installation:** Float, Glue-down, Nail-down
- This product may be floated over radiant heat.*

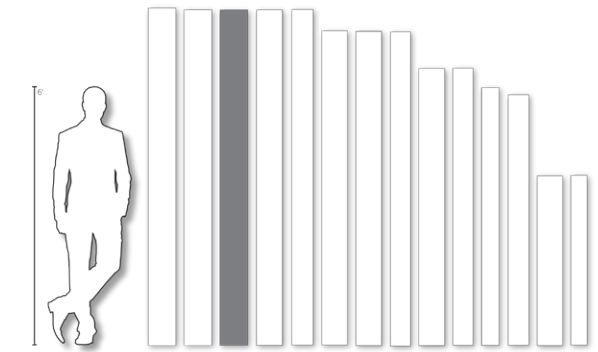

Length	Width	Thickness	Boards/Ctn	Area	Weight	Ctn/Pallet	Pallets/Cont.
95 3/8"	7 7/8"	1/2"	7	36.598ft ²	54lbs	50	16

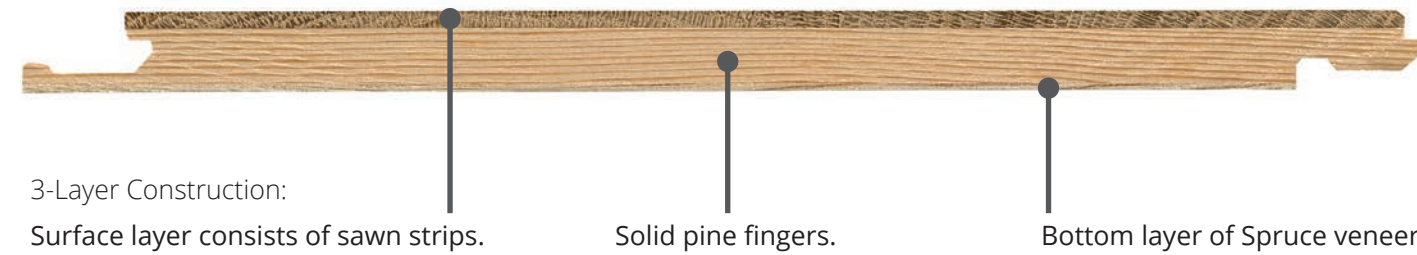



TRES COLLECTION

ASH CERIALE

133NACA1VKW 0

- Design:** 3-Strip
 - Features:** Scandinavian Ash, Stained, Square Edges, Smooth
 - Surface Treatment:** Matte Finish (UV-Cured Acrylic)
 - Wear Layer:** Approx. 2.5mm
 - Grading:** Variation
 - Joint:** Woodloc® 5G
 - Guarantee:** Lifetime Structural
25 Year Wear Through
 - Installation:** Float, Glue-down, Nail-down
- This product may be floated over radiant heat.*

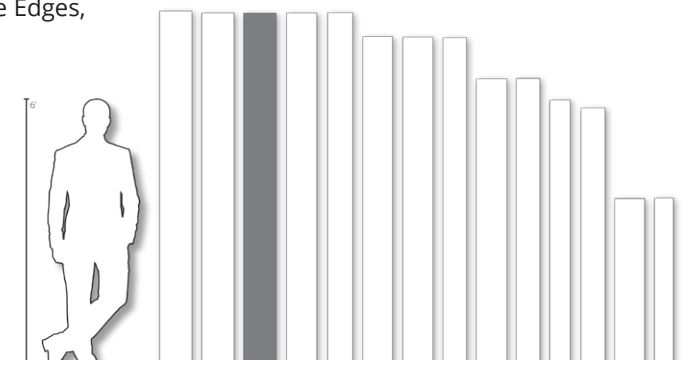

Length	Width	Thickness	Boards/Ctn	Area	Weight	Ctn/Pallet	Pallets/Cont.
95 3/8"	7 7/8"	1/2"	7	36.598ft ²	54lbs	50	16



3-Layer Construction:

Surface layer consists of sawn strips.

Solid pine fingers.

Bottom layer of Spruce veneer.



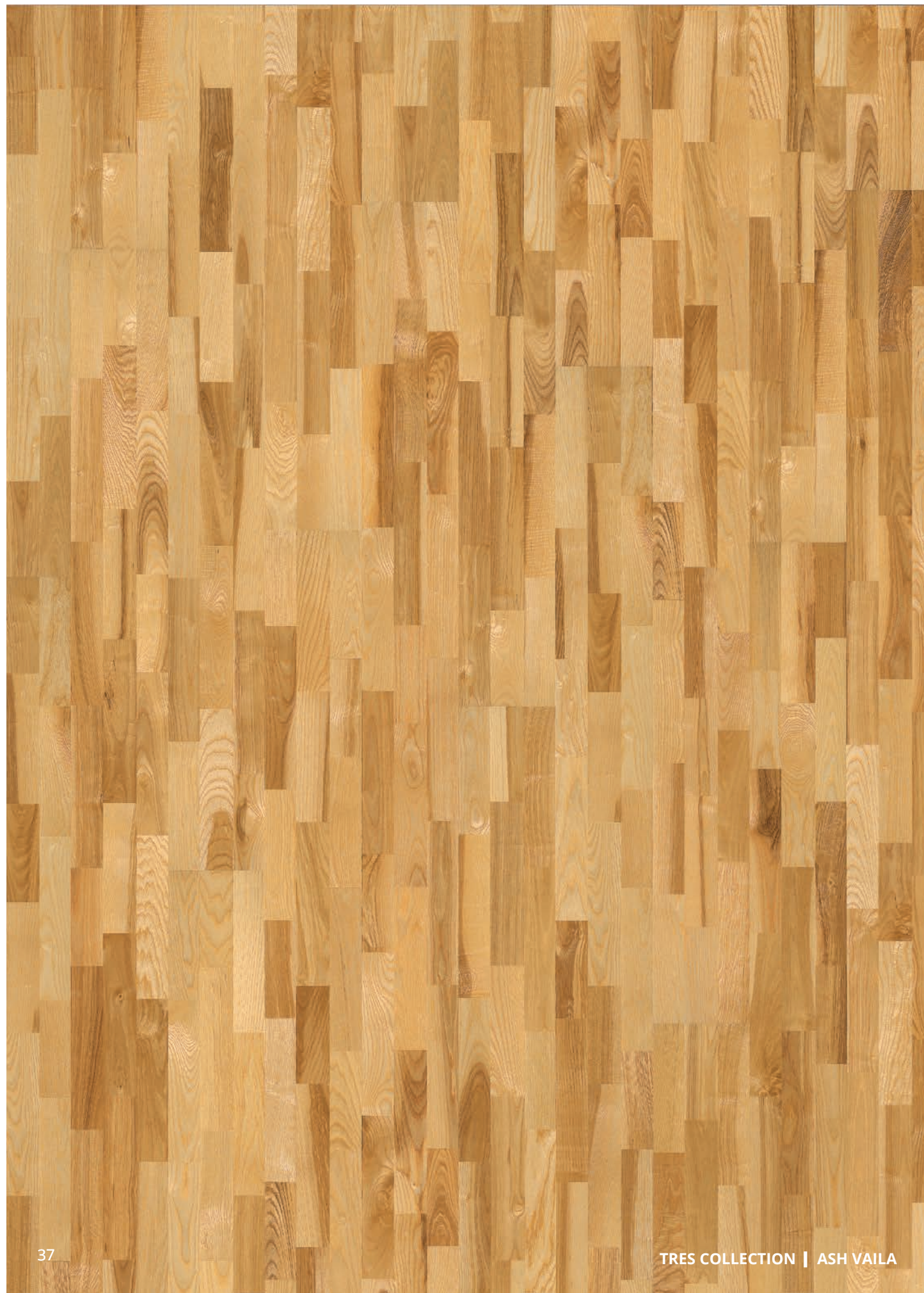

TRES COLLECTION

ASH VAILA

133NACAK50KW 0

- Design:** 3-Strip
 - Features:** Scandinavian Ash, Square Edges, Smooth
 - Surface Treatment:** Silk Matte Finish (UV-Cured Acrylic)
 - Wear Layer:** Approx. 2.5mm
 - Grading:** Variation
 - Joint:** Woodloc® 5G
 - Guarantee:** Lifetime Structural
25 Year Wear Through
 - Installation:** Float, Glue-down, Nail-down
- This product may be floated over radiant heat.*

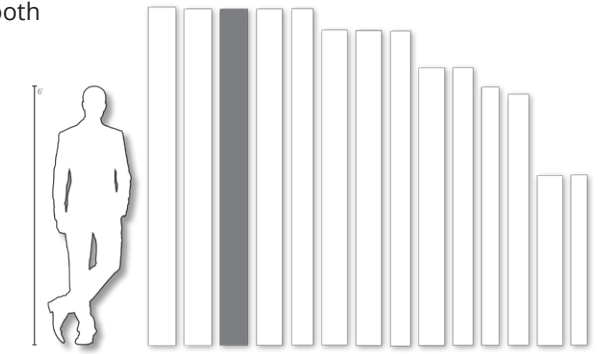

Length	Width	Thickness	Boards/Ctn	Area	Weight	Ctn/Pallet	Pallets/Cont.
95 3/8"	7 7/8"	1/2"	7	36.598ft ²	54lbs	50	16





TRES COLLECTION

EUROPEAN MAPLE GOTHA

133N18EL50KW 0

- Design:** 3-Strip
- Features:** European Maple, Square Edges, Smooth
- Surface Treatment:** Silk Matte Finish (UV-Cured Acrylic)
- Wear Layer:** Approx. 2.5mm
- Grading:** Variation
- Joint:** Woodloc® 5G
- Guarantee:** Lifetime Structural
25 Year Wear Through
- Installation:** Float, Glue-down, Nail-down

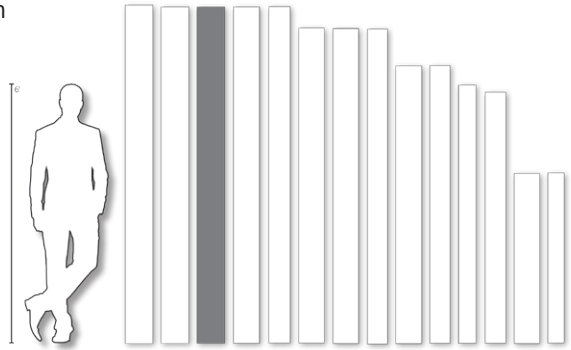

Length	Width	Thickness	Boards/Ctn	Area	Weight	Ctn/Pallet	Pallets/Cont.
95 3/8"	7 7/8"	1/2"	7	36.598ft²	54lbs	50	16





GROUND COLLECTION



ASH CORAL

GROUND COLLECTION

A collection of 3-strip floors based on timeless, natural, soft colors, inviting nature indoors.

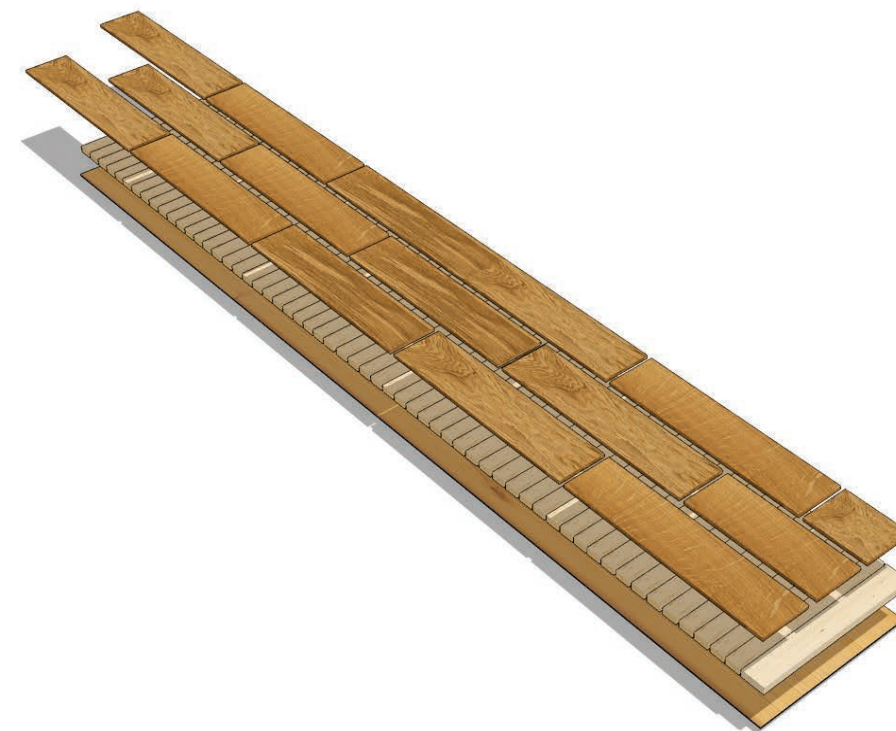



GROUND COLLECTION

OAK CLAY

133B14EKHGKW226

- Design:** 3-Strip
- Features:** European Oak, Stained, Square Edge, Smooth
- Surface Treatment:** Matte Finish (UV-Cured Acrylic)
- Wear Layer:** Approx. 2.6mm
- Grading:** Variation
- Joint:** Woodloc® 5G
- Guarantee:** Lifetime Structural
25 Year Wear Through
- Installation:** Float, Glue-down, Nail-down
This product may be floated over radiant heat.

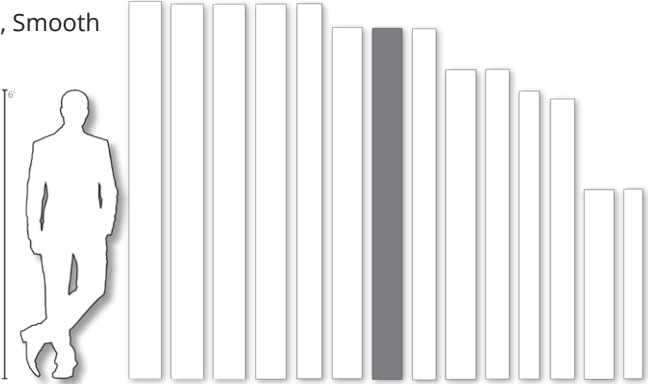

Length	Width	Thickness	Boards/Ctn	Area	Weight	Ctn/Pallet	Pallets/Cont.
89 1/4"	7 3/8"	1/2"	8	36.71ft ²	54lbs	35	22





GROUND COLLECTION

OAK CHALK

133B14EKLCKW226

- Design:** 3-Strip
 - Features:** European Oak, Stained, Square Edge, Smooth
 - Surface Treatment:** Matte Finish (UV-Cured Acrylic)
 - Wear Layer:** Approx. 2.6mm
 - Grading:** Variation
 - Joint:** Woodloc® 5G
 - Guarantee:** Lifetime Structural
25 Year Wear Through
 - Installation:** Float, Glue-down, Nail-down
- This product may be floated over radiant heat.*

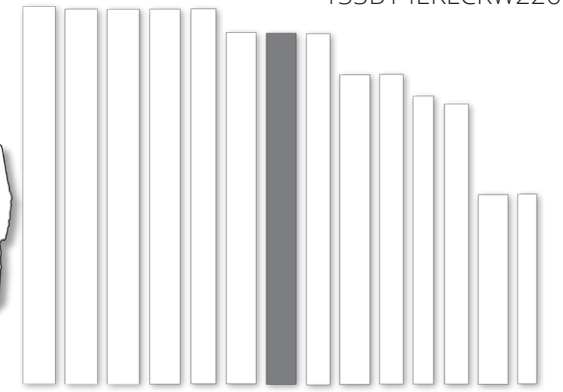

Length	Width	Thickness	Boards/Ctn	Area	Weight	Ctn/Pallet	Pallets/Cont.
89 1/4"	7 3/8"	1/2"	8	36.71ft ²	54lbs	35	22



3-Layer Construction:

Surface layer consists of sawn strips.

Solid pine fingers.

Bottom layer of Spruce veneer.





GROUND COLLECTION

OAK SAND

133B22EK1KKW226

- Design:** 3-Strip
- Features:** European Oak, Stained, Square Edge, Smooth
- Surface Treatment:** Matte Finish (UV-Cured Acrylic)
- Wear Layer:** Approx. 2.6mm
- Grading:** Lively
- Joint:** Woodloc® 5G
- Guarantee:** Lifetime Structural
25 Year Wear Through
- Installation:** Float, Glue-down, Nail-down

This product may be floated over radiant heat.

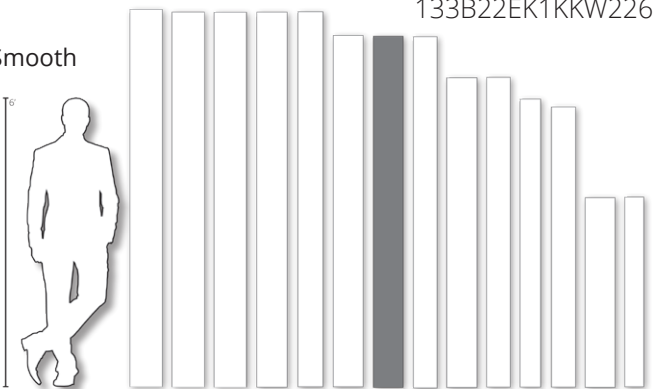

Length	Width	Thickness	Boards/Ctn	Area	Weight	Ctn/Pallet	Pallets/Cont.
89 1/4"	7 3/8"	1/2"	8	36.71ft ²	54lbs	35	22



3-Layer Construction:
 Surface layer consists of sawn strips. Solid pine fingers. Bottom layer of Spruce veneer.





GROUND COLLECTION

OAK SEED

133B14EKHNKW226

- Design:** 3-Strip
- Features:** European Oak, Stained, Square Edge, Smooth
- Surface Treatment:** Matte Finish (UV-Cured Acrylic)
- Wear Layer:** Approx. 2.6mm
- Grading:** Variation
- Joint:** Woodloc® 5G
- Guarantee:** Lifetime Structural
25 Year Wear Through
- Installation:** Float, Glue-down, Nail-down

This product may be floated over radiant heat.

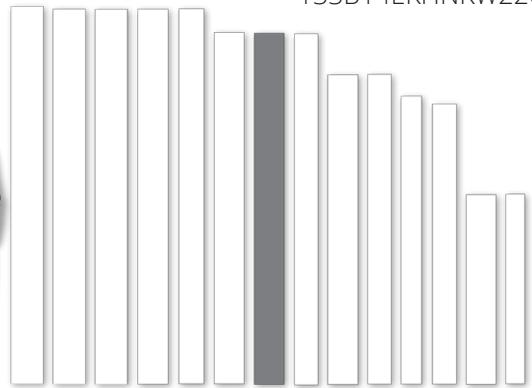

Length	Width	Thickness	Boards/Ctn	Area	Weight	Ctn/Pallet	Pallets/Cont.
89 1/4"	7 3/8"	1/2"	8	36.71ft ²	54lbs	35	22



3-Layer Construction:

Surface layer consists of sawn strips.

Solid pine fingers.

Bottom layer of Spruce veneer.





GROUND COLLECTION

ASH CORAL

133B11AKLCKW226

- Design:** 3-Strip
- Features:** Ash, Stained, Square Edge, Smooth
- Surface Treatment:** Matte Finish (UV-Cured Acrylic)
- Wear Layer:** Approx. 2.6mm
- Grading:** Lively
- Joint:** Woodloc® 5G
- Guarantee:** Lifetime Structural
25 Year Wear Through
- Installation:** Float, Glue-down, Nail-down
This product may be floated over radiant heat.

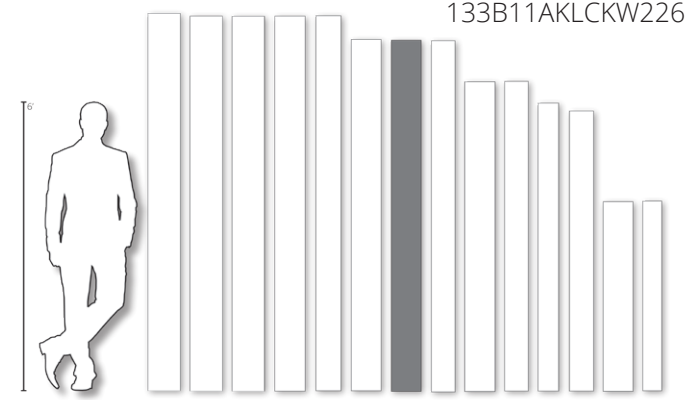

Length	Width	Thickness	Boards/Ctn	Area	Weight	Ctn/Pallet	Pallets/Cont.
89 1/4"	7 3/8"	1/2"	8	36.71ft ²	54lbs	35	22





CANVAS COLLECTION

OAK TAPA



OAK TAPA

CANVAS COLLECTION

An animated array of on-trend colors that add and enhance any designer's artistic palette.





CANVAS COLLECTION

OAK CURIO

13106AEKA1KW185

- Design:** Plank
 - Features:** Oak, Stained, Micro Beveled Edges, Brushed
 - Surface Treatment:** Matte Finish (UV-Cured Acrylic)
 - Wear Layer:** Approx. 3mm
 - Grading:** Lively
 - Joint:** Woodloc® 5G
 - Guarantee:** Lifetime Structural
25 Year Wear Through
 - Installation:** Float, Glue-down, Nail-down
- This product may be floated over radiant heat.*

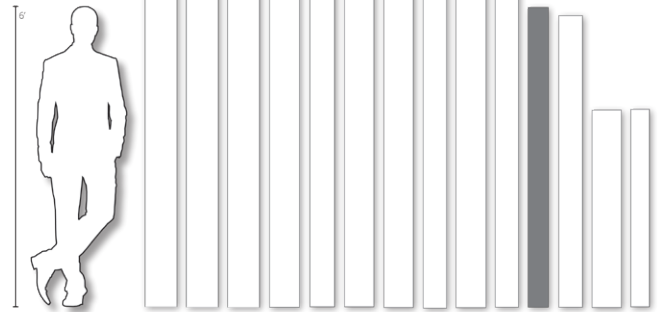

Length	Width	Thickness	Boards/Ctn	Area	Weight	Ctn/Pallet	Pallets/Cont.
73 1/4"	5"	1/2"	7	17.782ft²	28lbs	63	24

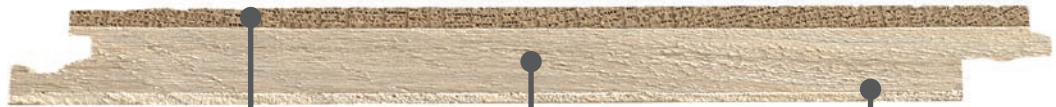

3-Layer Construction:
 Surface layer: sawn plank. Solid pine fingers. Bottom layer of Spruce veneer.





CANVAS COLLECTION

OAK TUFT

13106AEK1BKW185

- Design:** Plank
- Features:** Oak, Stained, Micro Beveled Edges, Brushed
- Surface Treatment:** Matte Finish (UV-Cured Acrylic)
- Wear Layer:** Approx. 3mm
- Grading:** Variation
- Joint:** Woodloc® 5G
- Guarantee:** Lifetime Structural
25 Year Wear Through
- Installation:** Float, Glue-down, Nail-down
This product may be floated over radiant heat.

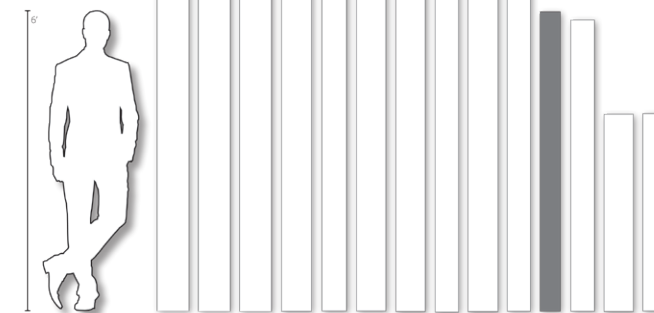

Length	Width	Thickness	Boards/Ctn	Area	Weight	Ctn/Pallet	Pallets/Cont.
73 1/4"	5"	1/2"	7	17.782ft²	28lbs	63	24





CANVAS COLLECTION

OAK ETCH

13106AEK15KW185

- Design:** Plank
- Features:** Rustic Oak, Stained, Micro Beveled Edges, Brushed
- Surface Treatment:** Matte Finish (UV-Cured Acrylic)
- Wear Layer:** Approx. 3mm
- Grading:** Lively
- Joint:** Woodloc® 5G
- Guarantee:** Lifetime Structural
25 Year Wear Through
- Installation:** Float, Glue-down, Nail-down

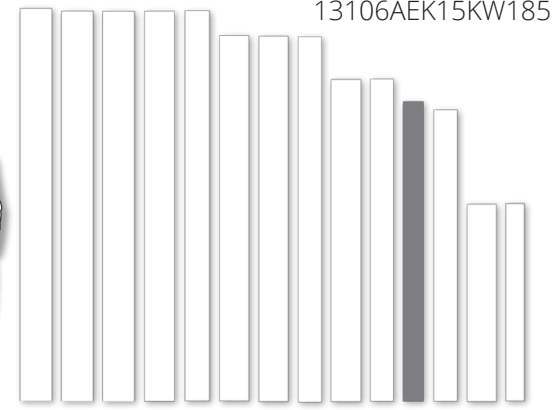

This product may be floated over radiant heat.

Length	Width	Thickness	Boards/Ctn	Area	Weight	Ctn/Pallet	Pallets/Cont.
73 1/4"	5"	1/2"	7	17.782ft ²	28lbs	63	24





CANVAS COLLECTION

OAK TAPA

13103AEK15KW185

- Design:** Plank
 - Features:** Oak, Micro Beveled Edges, Smooth
 - Surface Treatment:** Matte Finish (UV-Cured Acrylic)
 - Wear Layer:** Approx. 3mm
 - Grading:** Calm
 - Joint:** Woodloc® 5G
 - Guarantee:** Lifetime Structural
25 Year Wear Through
 - Installation:** Float, Glue-down, Nail-down
- This product may be floated over radiant heat.*

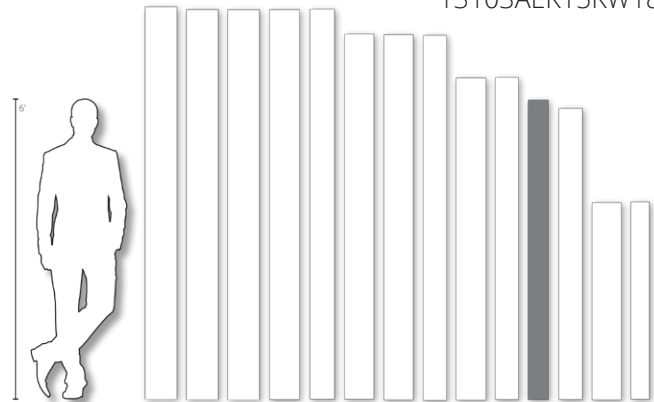

Length	Width	Thickness	Boards/Ctn	Area	Weight	Ctn/Pallet	Pallets/Cont.
73 1/4"	5"	1/2"	7	17.782ft ²	28lbs	63	24





CANVAS COLLECTION

OAK CARBON

13106AEK1RKW185

- Design:** Plank
 - Features:** Oak, Stained, Micro Beveled Edges, Brushed
 - Surface Treatment:** Matte Finish (UV-Cured Acrylic)
 - Wear Layer:** Approx. 3mm
 - Grading:** Lively
 - Joint:** Woodloc® 5G
 - Guarantee:** Lifetime Structural
25 Year Wear Through
 - Installation:** Float, Glue-down, Nail-down
- This product may be floated over radiant heat.*

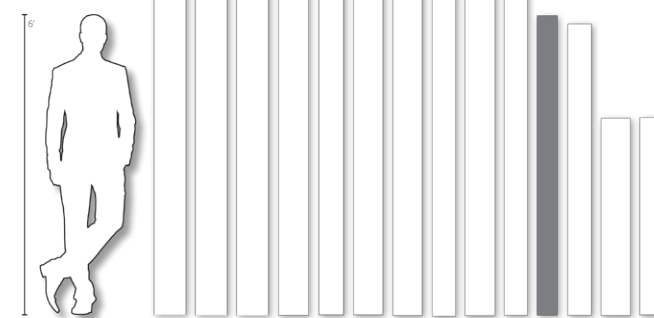

Length	Width	Thickness	Boards/Ctn	Area	Weight	Ctn/Pallet	Pallets/Cont.
73 1/4"	5"	1/2"	7	17.782ft²	28lbs	63	24

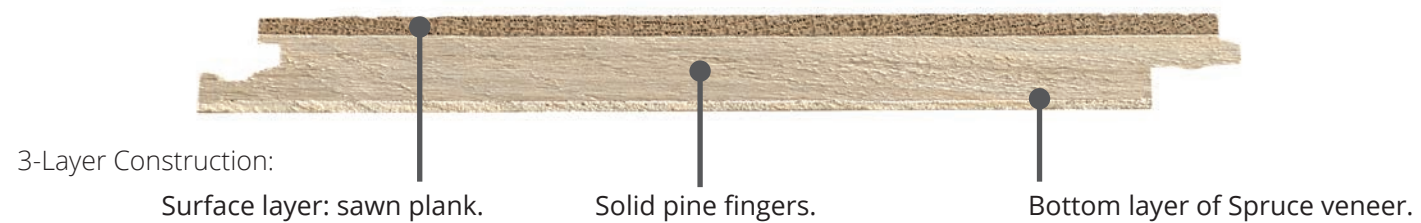



CANVAS COLLECTION

OAK MOREL | SPECIAL ORDER

13103AEK1IKW185

- Design:** Plank
- Features:** Oak, Stained, Micro Beveled Edges, Brushed
- Surface Treatment:** Matte Finish (UV-Cured Acrylic)
- Wear Layer:** Approx. 3mm
- Grading:** Variation
- Joint:** Woodloc® 5G
- Guarantee:** Lifetime Structural
25 Year Wear Through
- Installation:** Float, Glue-down, Nail-down
This product may be floated over radiant heat.

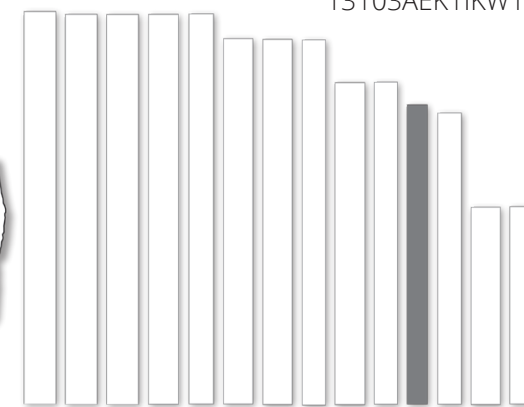

Length	Width	Thickness	Boards/Ctn	Area	Weight	Ctn/Pallet	Pallets/Cont.
73 1/4"	5"	1/2"	7	17.782ft²	28lbs	63	24



3-Layer Construction:

Surface layer: sawn plank.

Solid pine fingers.

Bottom layer of Spruce veneer.





CANVAS COLLECTION

OAK REITER

13103AEK1UKW185

- Design:** Plank
- Features:** Oak, Stained, Micro Beveled Edges, Brushed
- Surface Treatment:** Matte Finish (UV-Cured Acrylic)
- Wear Layer:** Approx. 3mm
- Grading:** Variation
- Joint:** Woodloc® 5G
- Guarantee:** Lifetime Structural
25 Year Wear Through
- Installation:** Float, Glue-down, Nail-down
This product may be floated over radiant heat.

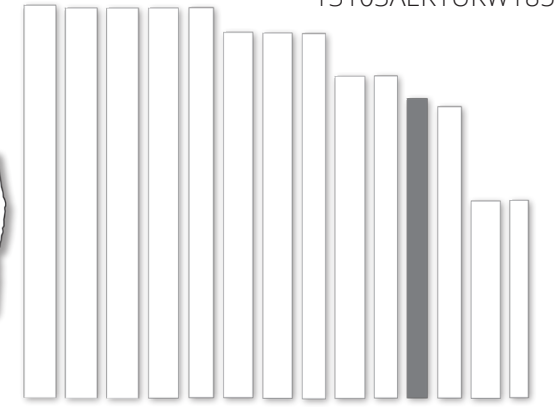

Length	Width	Thickness	Boards/Ctn	Area	Weight	Ctn/Pallet	Pallets/Cont.
73 1/4"	5"	1/2"	7	17.782ft ²	28lbs	63	24

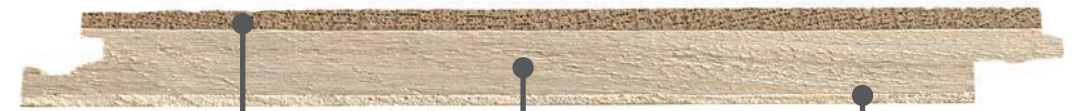

3-Layer Construction:

Surface layer: sawn plank.

Solid pine fingers.

Bottom layer of Spruce veneer.





CANVAS COLLECTION

OAK MUSE

13103AEK1VKW185

- Design:** Plank
- Features:** Oak, Stained, Micro Beveled Edges, Brushed
- Surface Treatment:** Matte Finish (UV-Cured Acrylic)
- Wear Layer:** Approx. 3mm
- Grading:** Variation
- Joint:** Woodloc® 5G
- Guarantee:** Lifetime Structural
25 Year Wear Through
- Installation:** Float, Glue-down, Nail-down

This product may be floated over radiant heat.

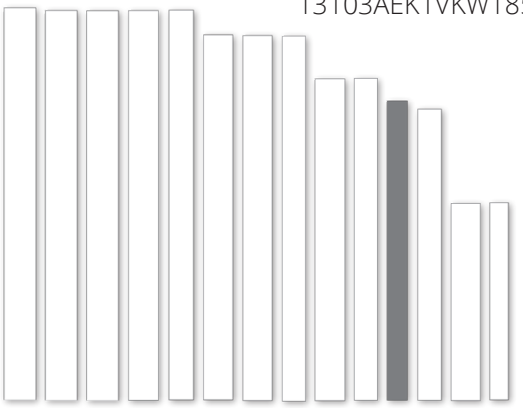

Length	Width	Thickness	Boards/Ctn	Area	Weight	Ctn/Pallet	Pallets/Cont.
73 1/4"	5"	1/2"	7	17.782ft²	28lbs	63	24





CANVAS COLLECTION

OAK CADENCE

13103AEK1PKW185

- Design:** Plank
- Features:** Oak, Stained, Micro Beveled Edges, Brushed
- Surface Treatment:** Matte Finish (UV-Cured Acrylic)
- Wear Layer:** Approx. 3mm
- Grading:** Variation
- Joint:** Woodloc® 5G
- Guarantee:** Lifetime Structural
25 Year Wear Through
- Installation:** Float, Glue-down, Nail-down
This product may be floated over radiant heat.

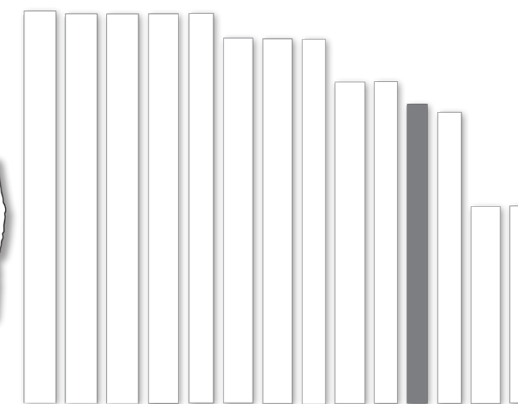

Length	Width	Thickness	Boards/Ctn	Area	Weight	Ctn/Pallet	Pallets/Cont.
73 1/4"	5"	1/2"	7	17.782ft ²	28lbs	63	24





CANVAS COLLECTION

OAK MOSTRA

13106AEK1VKW185

- Design:** Plank
- Features:** Oak, Stained, Micro Beveled Edges, Brushed
- Surface Treatment:** Matte Finish (UV-Cured Acrylic)
- Wear Layer:** Approx. 3mm
- Grading:** Lively
- Joint:** Woodloc® 5G
- Guarantee:** Lifetime Structural
25 Year Wear Through
- Installation:** Float, Glue-down, Nail-down

This product may be floated over radiant heat.

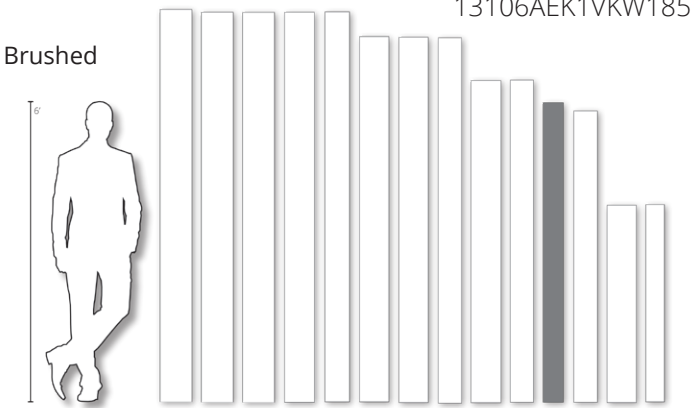

Length	Width	Thickness	Boards/Ctn	Area	Weight	Ctn/Pallet	Pallets/Cont.
73 1/4"	5"	1/2"	7	17.782ft²	28lbs	63	24





CANVAS COLLECTION

OAK FAWN

13103AEK1KKW185

- Design:** Plank
- Features:** Oak, Stained, Micro Beveled Edges, Brushed
- Surface Treatment:** Matte Finish (UV-Cured Acrylic)
- Wear Layer:** Approx. 3mm
- Grading:** Variation
- Joint:** Woodloc® 5G
- Guarantee:** Lifetime Structural
25 Year Wear Through
- Installation:** Float, Glue-down, Nail-down
This product may be floated over radiant heat.

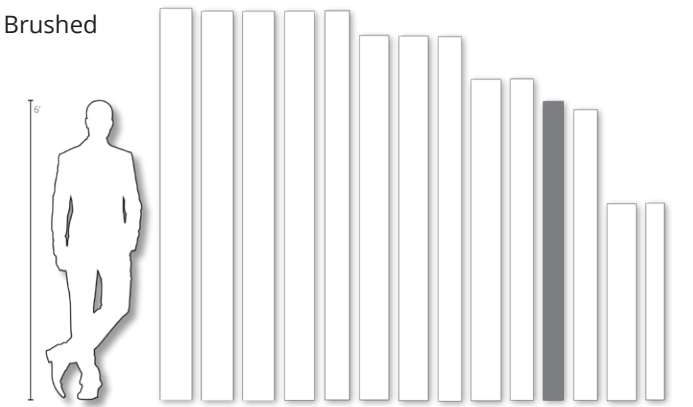

Length	Width	Thickness	Boards/Ctn	Area	Weight	Ctn/Pallet	Pallets/Cont.
73 1/4"	5"	1/2"	7	17.782ft²	28lbs	63	24





CANVAS COLLECTION

OAK HENNA

13106AEK1NKW185

- Design:** Plank
- Features:** Oak, Stained, Micro Beveled Edges, Brushed
- Surface Treatment:** Matte Finish (UV-Cured Acrylic)
- Wear Layer:** Approx. 3mm
- Grading:** Lively
- Joint:** Woodloc® 5G
- Guarantee:** Lifetime Structural
25 Year Wear Through
- Installation:** Float, Glue-down, Nail-down

This product may be floated over radiant heat.

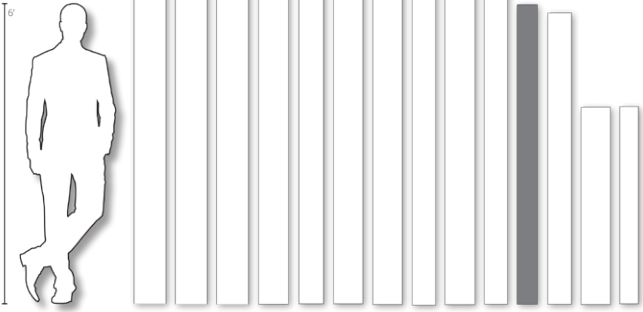

Length	Width	Thickness	Boards/Ctn	Area	Weight	Ctn/Pallet	Pallets/Cont.
73 1/4"	5"	1/2"	7	17.782ft²	28lbs	63	24





CANVAS COLLECTION

OAK HEATHER

13106AEK1GKW185

- Design:** Plank
- Features:** Oak, Stained, Micro Beveled Edges, Brushed
- Surface Treatment:** Matte Finish (UV-Cured Acrylic)
- Wear Layer:** Approx. 3mm
- Grading:** Lively
- Joint:** Woodloc® 5G
- Guarantee:** Lifetime Structural
25 Year Wear Through
- Installation:** Float, Glue-down, Nail-down
This product may be floated over radiant heat.

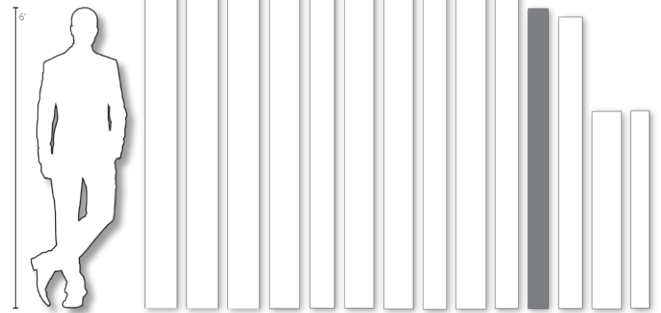

Length	Width	Thickness	Boards/Ctn	Area	Weight	Ctn/Pallet	Pallets/Cont.
73 1/4"	5"	1/2"	7	17.782ft²	28lbs	63	24





FOUNDERS COLLECTION



OAK STURE

FOUNDERS COLLECTION

The Founders Collection pays tribute to the pioneering founding family members behind Kährs. A heavily brushed, handscraped surface, enhanced by a Nature Oil finish, showcases the grain and texture of the wood – reflecting the masters' dedication to preserving the natural beauty and craftsmanship of wood floors.





FOUNDERS COLLECTION

OAK GUSTAF

151N7BEKFKW240

- Design:** Plank
- Features:** Rustic Scandinavian Oak, Stained, Beveled Edges, Brushed, Handscraped
- Surface Treatment:** Oil
- Wear Layer:** Approx. 3.5mm (1/8")
- Grading:** Dynamic
- Joint:** Woodloc® 5S
- Guarantee:** Lifetime Structural
- Installation:** Float, Glue-down, Nail-down

This product may be floated over radiant heat.

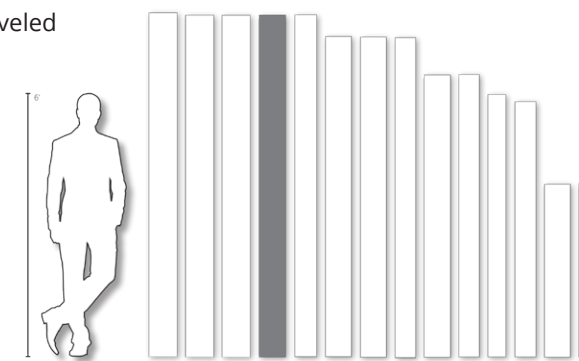

Length	Width	Thickness	Boards/Ctn	Area	Weight	Ctn/Pallet	Pallets/Cont.
95 1/4"	7 3/8"	5/8"	6	29.279ft²	49lbs	50	16



3-Layer Construction:

Surface layer: sawn plank.

Solid pine fingers.

Bottom layer of poplar veneer.

This product must be oiled immediately after installation and prior to use.





FOUNDERS COLLECTION

OAK STURE

151N7BEKFMKW240

- Design:** Plank
 - Features:** Rustic Scandinavian Oak, Stained, Beveled Edges, Handscraped, Brushed, Lightly Smoked
 - Surface Treatment:** Oil
 - Wear Layer:** Approx. 3.5mm (1/8")
 - Grading:** Dynamic
 - Joint:** Woodloc® 5S
 - Guarantee:** Lifetime Structural
 - Installation:** Float, Glue-down, Nail-down
- This product may be floated over radiant heat.*

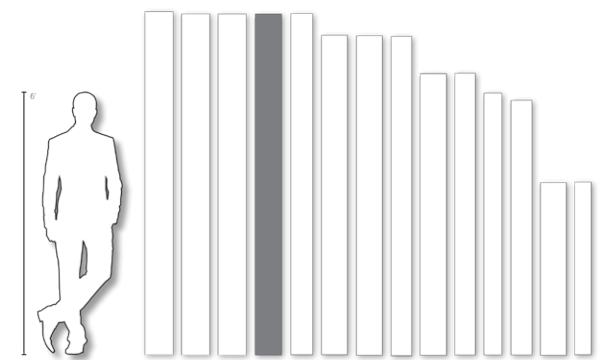

Length	Width	Thickness	Boards/Ctn	Area	Weight	Ctn/Pallet	Pallets/Cont.
95 1/4"	7 3/8"	5/8"	6	29.279ft²	49lbs	50	16



3-Layer Construction:

Surface layer: sawn plank.

Solid pine fingers.

Bottom layer of poplar veneer.

This product must be oiled immediately after installation and prior to use.





FOUNDERS COLLECTION

OAK FREDRIK

151N7BEKFCKW240

- Design:** Plank
 - Features:** Rustic Scandinavian Oak, Stained, Beveled Edges, Handscraped, Brushed, Smoked
 - Surface Treatment:** Oil
 - Wear Layer:** Approx. 3.5mm (1/8")
 - Grading:** Dynamic
 - Joint:** Woodloc® 5S
 - Guarantee:** Lifetime Structural
 - Installation:** Float, Glue-down, Nail-down
- This product may be floated over radiant heat.*

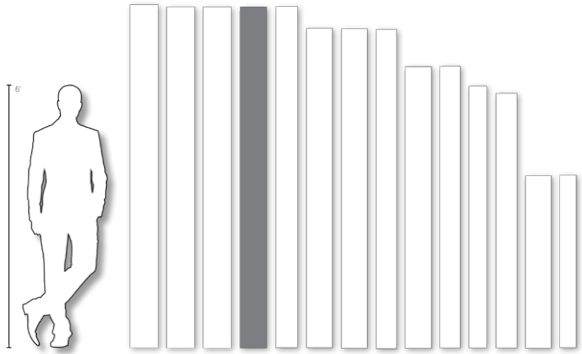

Length	Width	Thickness	Boards/Ctn	Area	Weight	Ctn/Pallet	Pallets/Cont.
95 1/4"	7 3/8"	5/8"	6	29.279ft²	49lbs	50	16



3-Layer Construction:
 Surface layer: sawn plank. Solid pine fingers. Bottom layer of poplar veneer.

This product must be oiled immediately after installation and prior to use.





FOUNDERS COLLECTION

OAK ULF

151N7BEKFBKW240

- Design:** Plank
- Features:** Rustic Scandinavian Oak, Stained, Beveled Edges, Handscraped, Brushed
- Surface Treatment:** Oil
- Wear Layer:** Approx. 3.5mm (1/8")
- Grading:** Dynamic
- Joint:** Woodloc® 5S
- Guarantee:** Lifetime Structural
- Installation:** Float, Glue-down, Nail-down

This product may be floated over radiant heat.

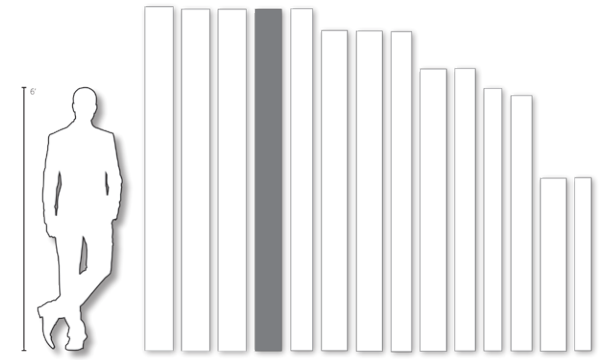

Length	Width	Thickness	Boards/Ctn	Area	Weight	Ctn/Pallet	Pallets/Cont.
95 1/4"	7 3/8"	5/8"	6	29.279ft²	49lbs	50	16



3-Layer Construction:

Surface layer: sawn plank.

Solid pine fingers.

Bottom layer of poplar veneer.

This product must be oiled immediately after installation and prior to use.





CLASSIC NOUVEAU
COLLECTION

OAK NOUVEAU WHITE



OAK NOUVEAU GRAY

CLASSIC NOUVEAU COLLECTION

The Classic Nouveau Collection is a modern take on wood floors: trendy colors, matte finish, and wide plank design. This collection has been refined through brushing, staining, and the use of a bevel on all four edges. These floors are as beautiful as they are easy to look after, becoming an instant classic in any space.





CLASSIC NOUVEAU COLLECTION

OAK NOUVEAU GRAY

151NAYEKD1KW240

- Design:** Plank
 - Features:** Brushed European Oak, Stained, Beveled
 - Surface Treatment:** Matte Finish (UV-Cured Acrylic)
 - Wear Layer:** Approx. 3.5mm (1/8")
 - Grading:** Lively
 - Joint:** Woodloc® 5S
 - Guarantee:** Lifetime Structural
25 Year Wear Through
 - Installation:** Float, Glue-down, Nail-down
- This product may be floated over radiant heat.*

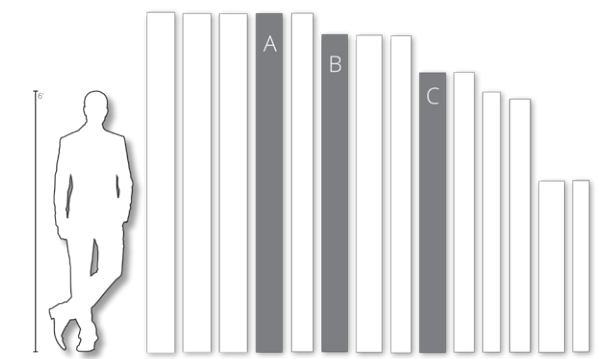

	Length	Width	Thickness	Boards/Ctn	Area	Weight	Ctn/Pallet	Pallets/Cont.
Pattern A	95 1/4"	7 3/8"	5/8"	6	29.279ft²	49lbs	50	16



3-Layer Construction:

Surface layer: sawn plank.

Solid pine fingers.

Bottom layer of poplar veneer.





CLASSIC NOUVEAU COLLECTION

OAK NOUVEAU BLACK

151L8AEK1JKW240

- Design:** Plank
 - Features:** Brushed European Oak, Stained, Beveled
 - Surface Treatment:** Matte Finish (UV-Cured Acrylic)
 - Wear Layer:** Approx. 3.5mm (1/8")
 - Grading:** Lively
 - Joint:** Woodloc® 5S
 - Guarantee:** Lifetime Structural
25 Year Wear Through
 - Installation:** Float, Glue-down, Nail-down
- This product may be floated over radiant heat.*

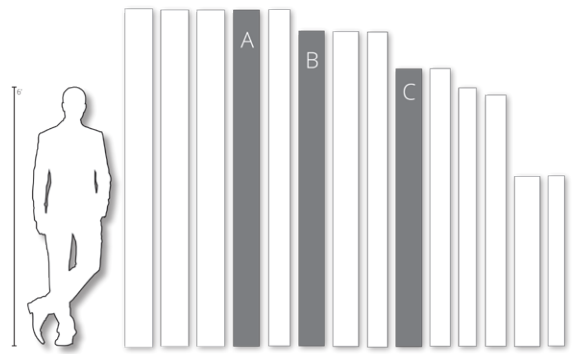

	Length	Width	Thickness	Boards/Ctn	Area	Weight	Ctn/Pallet	Pallets/Cont.
Pattern A	95 1/4"	7 3/8"	5/8"	6	29.279ft²	49lbs	50	16



3-Layer Construction:
 Surface layer: sawn plank. Solid pine fingers. Bottom layer of poplar veneer.





CLASSIC NOUVEAU COLLECTION

- Design:** Plank
 - Features:** Brushed European Oak, Stained, Beveled
 - Surface Treatment:** Matte Finish (UV-Cured Acrylic)
 - Wear Layer:** Approx. 3.5mm (1/8")
 - Grading:** Lively
 - Joint:** Woodloc® 5S
 - Guarantee:** Lifetime Structural
25 Year Wear Through
 - Installation:** Float, Glue-down, Nail-down
- This product may be floated over radiant heat.*

OAK NOUVEAU BLONDE

- *Pattern A: 151N8AEKP1KW240
- *Pattern B: 151N8AEKP1KW220
- *Pattern C: 151N8AEKP1KW200

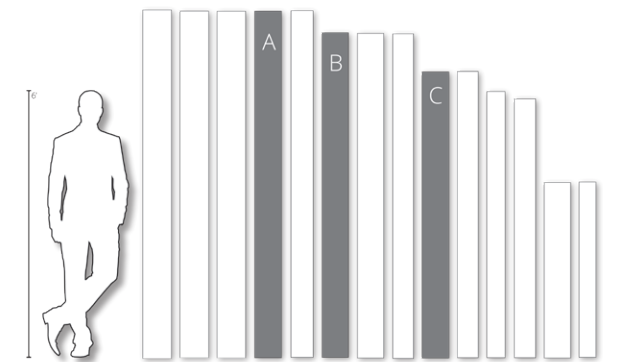

	Length	Width	Thickness	Boards/Ctn	Area	Weight	Ctn/Pallet	Pallets/Cont.
Pattern A	95 1/4"	7 3/8"	5/8"	6	29.279ft ²	49lbs	50	16
Pattern B	89 1/4"	7 3/8"	5/8"	6	27.341ft ²	47lbs	50	16
Pattern C	78 3/4"	7 3/8"	5/8"	6	24.111ft ²	45lbs	50	16

**Nouveau Blonde SKUs vary in availability. Please reach out to your Kahrs rep for details.*





CLASSIC NOUVEAU COLLECTION

OAK NOUVEAU GREIGE

151N8AEKGGKW220

- Design:** Plank
 - Features:** Brushed European Oak, Stained, Beveled, Smoked
 - Surface Treatment:** Matte Finish (UV-Cured Acrylic)
 - Wear Layer:** Approx. 3.5mm (1/8")
 - Grading:** Lively
 - Joint:** Woodloc® 5S
 - Guarantee:** Lifetime Structural
25 Year Wear Through
 - Installation:** Float, Glue-down, Nail-down
- This product may be floated over radiant heat.*

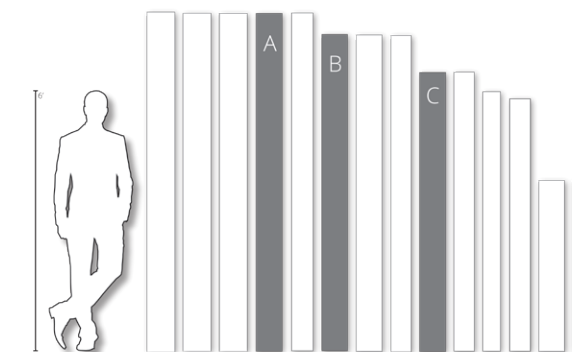

	Length	Width	Thickness	Boards/Ctn	Area	Weight	Ctn/Pallet	Pallets/Cont.
Pattern B	89 1/4"	7 3/8"	5/8"	6	27.341ft ²	47lbs	50	16



3-Layer Construction:

Surface layer: sawn plank.

Solid pine fingers.

Bottom layer of poplar veneer.





CLASSIC NOUVEAU COLLECTION

OAK NOUVEAU LACE

151NAYEKS1KW240

- Design:** Plank
 - Features:** Brushed European Oak, Stained, Beveled
 - Surface Treatment:** Matte Finish (UV-Cured Acrylic)
 - Wear Layer:** Approx. 3.5mm (1/8")
 - Grading:** Lively
 - Joint:** Woodloc® 5S
 - Guarantee:** Lifetime Structural
25 Year Wear Through
 - Installation:** Float, Glue-down, Nail-down
- This product may be floated over radiant heat.*

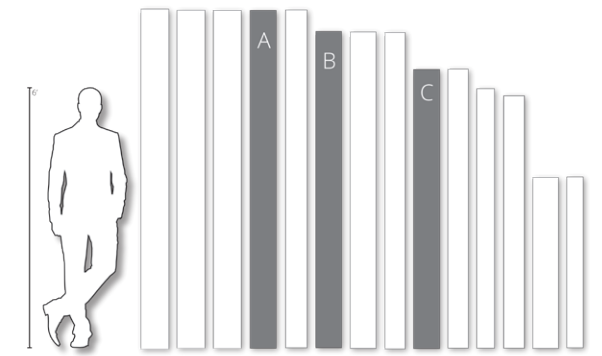

	Length	Width	Thickness	Boards/Ctn	Area	Weight	Ctn/Pallet	Pallets/Cont.
Pattern A	95 1/4"	7 3/8"	5/8"	6	29.279ft ²	49lbs	50	16



3-Layer Construction:

Surface layer: sawn plank.

Solid pine fingers.

Bottom layer of poplar veneer.





CLASSIC NOUVEAU COLLECTION

OAK NOUVEAU SNOW

151N8EEKOWKW220

- Design:** Plank
 - Features:** Brushed European Oak, Stained, Micro Bevel
 - Surface Treatment:** Matte Finish (UV-Cured Acrylic)
 - Wear Layer:** Approx. 3.5mm (1/8")
 - Grading:** Lively
 - Joint:** Woodloc® 5S
 - Guarantee:** Lifetime Structural
25 Year Wear Through
 - Installation:** Float, Glue-down, Nail-down
- This product may be floated over radiant heat.*

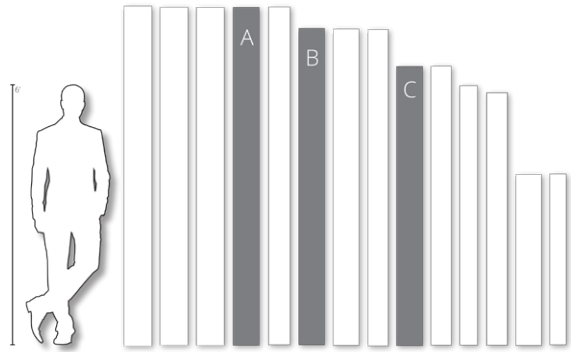

	Length	Width	Thickness	Boards/Ctn	Area	Weight	Ctn/Pallet	Pallets/Cont.
Pattern B	89 1/4"	7 3/8"	5/8"	6	27.341ft ²	47lbs	50	16



3-Layer Construction:
 Surface layer: sawn plank. Solid pine fingers. Bottom layer of poplar veneer.





CLASSIC NOUVEAU COLLECTION

OAK NOUVEAU TAUPE

151N9AEK18KW200

- Design:** Plank
 - Features:** Brushed European Oak, Stained, Beveled
 - Surface Treatment:** Matte Finish (UV-Cured Acrylic)
 - Wear Layer:** Approx. 3.5mm (1/8")
 - Grading:** Lively
 - Joint:** Woodloc® 5S
 - Guarantee:** Lifetime Structural
25 Year Wear Through
 - Installation:** Float, Glue-down, Nail-down
- This product may be floated over radiant heat.*

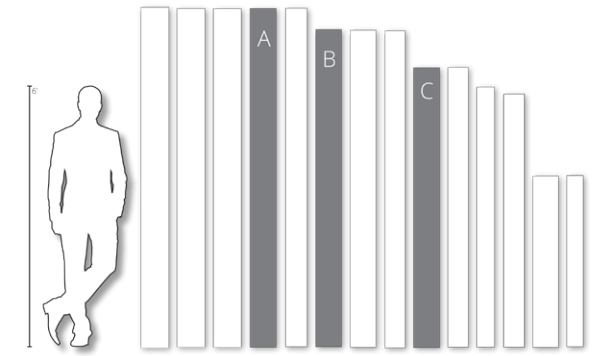

	Length	Width	Thickness	Boards/Ctn	Area	Weight	Ctn/Pallet	Pallets/Cont.
Pattern C	78 3/4"	7 3/8"	5/8"	6	24.111ft ²	45lbs	50	16



3-Layer Construction:

Surface layer: sawn plank.

Solid pine fingers.

Bottom layer of poplar veneer.





CLASSIC NOUVEAU COLLECTION

OAK NOUVEAU WHISPER

151N9AEK16KW200

- Design:** Plank
 - Features:** Brushed European Oak, Stained, Beveled
 - Surface Treatment:** Matte Finish (UV-Cured Acrylic)
 - Wear Layer:** Approx. 3.5mm (1/8")
 - Grading:** Lively
 - Joint:** Woodloc® 5S
 - Guarantee:** Lifetime Structural
25 Year Wear Through
 - Installation:** Float, Glue-down, Nail-down
- This product may be floated over radiant heat.*

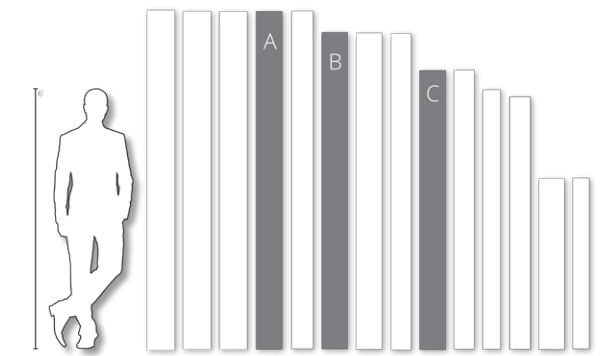

	Length	Width	Thickness	Boards/Ctn	Area	Weight	Ctn/Pallet	Pallets/Cont.
Pattern C	78 3/4"	7 3/8"	5/8"	6	24.111ft ²	45lbs	50	16



3-Layer Construction:

Surface layer: sawn plank.

Solid pine fingers.

Bottom layer of poplar veneer.





CLASSIC NOUVEAU COLLECTION

OAK NOUVEAU WHITE

151L8AEK1DKW220

- Design:** Plank
 - Features:** Brushed European Oak, Stained, Beveled
 - Surface Treatment:** Matte Finish (UV-Cured Acrylic)
 - Wear Layer:** Approx. 3.5mm (1/8")
 - Grading:** Lively
 - Joint:** Woodloc® 5S
 - Guarantee:** Lifetime Structural
25 Year Wear Through
 - Installation:** Float, Glue-down, Nail-down
- This product may be floated over radiant heat.*

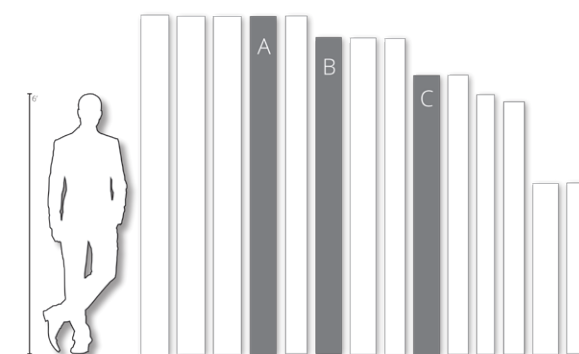

	Length	Width	Thickness	Boards/Ctn	Area	Weight	Ctn/Pallet	Pallets/Cont.
Pattern B	89 1/4"	7 3/8"	5/8"	6	27.341ft ²	47lbs	50	16



3-Layer Construction:

Surface layer: sawn plank.

Solid pine fingers.

Bottom layer of poplar veneer.





BEYOND RETRO
COLLECTION



NEW BEYOND RETRO COLLECTION

INSPIRED BY THE PAST, DESIGNED FOR THE FUTURE.

The new Beyond Retro Collection celebrates the combination of classical and modern design elements, with a sense of authenticity, warmth and modernity. The design of each floor, featuring unique stains with a warm, deep, silky, velvet and ultra-matte expression, is based on Scandinavian interior trends seen between the 1940s and 1970s. With the help of the Kährs archives in Sweden, which document our 160 years of history in wood flooring, we found the most suitable colors and styles to bring to the 21st century.



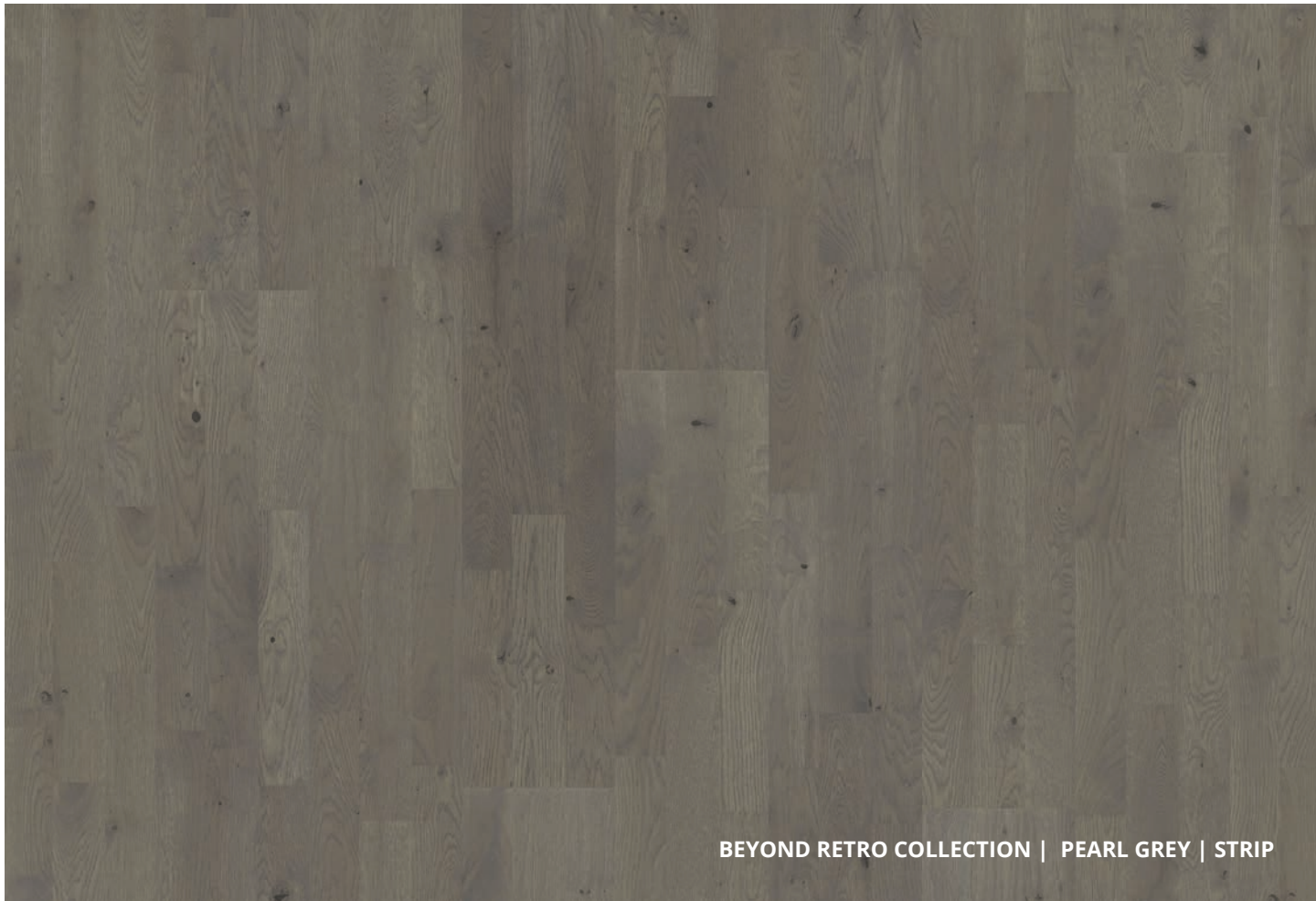

BEYOND RETRO COLLECTION | PEARL GREY | STRIP



BEYOND RETRO COLLECTION | PEARL GREY | PLANK

BEYOND RETRO COLLECTION

PEARL GREY

A. Strip: 153N6BEKR4KW240
B. Plank: 151N9AEKR4KW200

- Design:** Plank & 3-Strip Options
- Features:** All: Oak, Stained, Brushed
Plank: 4-Side Micro Bevel
Strip: Straight Edge
- Surface Treatment:** Ultra Matte Finish (UV-Cured Acrylic)
- Wear Layer:** Approx. 3.5mm
- Grading:** Plank: Dynamic
Strip: Lively
- Joint:** Woodloc® 5S
- Guarantee:** Lifetime Structural
25 Year Wear Through
- Installation:** Float, Glue-down, Nail-down
This product may be floated over radiant heat.

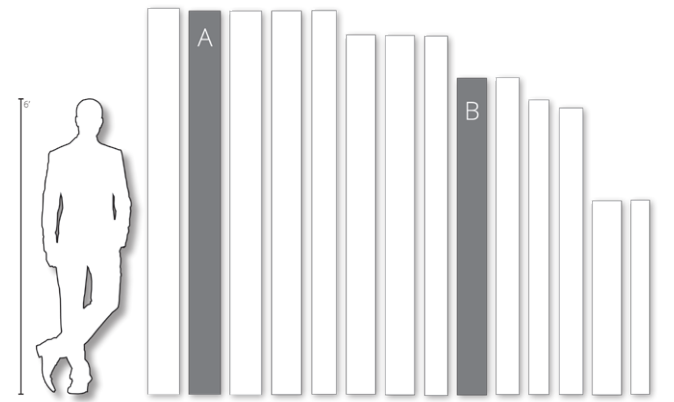

	Length	Width	Thickness	Boards/Ctn	Area	Weight	Ctn/Pallet	Pallets/Cont.
A. Strip	95 3/8"	7 7/8"	5/8"	6	31.324ft ²	54lbs	50	16
B. Plank	78 3/4"	7 3/8"	5/8"	6	24.111ft ²	40lbs	45	16



PEARL GREY | PLANK



BEYOND RETRO COLLECTION | LOFT WHITE | STRIP



BEYOND RETRO COLLECTION | LOFT WHITE | PLANK

BEYOND RETRO COLLECTION

LOFT WHITE

A. Strip: 153N6BEKM4KW240
 B. Plank: 151N9AEKM4KW200

- Design:** Plank & 3-Strip Options
- Features:** All: Oak, Stained, Brushed
 Plank: 4-Side Micro Bevel
 Strip: Straight Edge
- Surface Treatment:** Ultra Matte Finish (UV-Cured Acrylic)
- Wear Layer:** Approx. 3.5mm
- Grading:** Plank: Dynamic
 Strip: Lively
- Joint:** Woodloc® 5S
- Guarantee:** Lifetime Structural
 25 Year Wear Through
- Installation:** Float, Glue-down, Nail-down
This product may be floated over radiant heat.

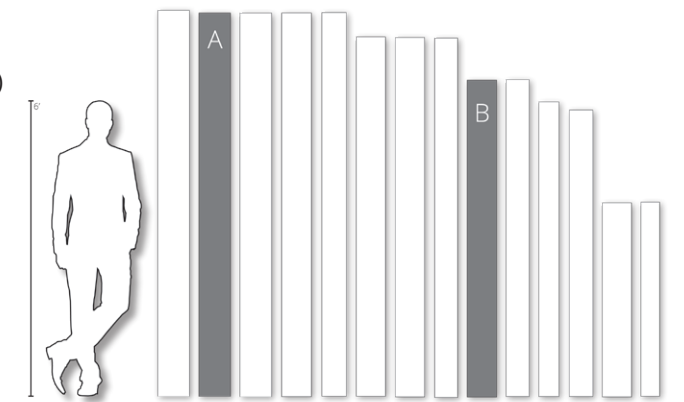

	Length	Width	Thickness	Boards/Ctn	Area	Weight	Ctn/Pallet	Pallets/Cont.
A. Strip	95 3/8"	7 7/8"	5/8"	6	31.324ft ²	54lbs	50	16
B. Plank	78 3/4"	7 3/8"	5/8"	6	24.111ft ²	40lbs	45	16



LOFT WHITE | PLANK



BEYOND RETRO COLLECTION | URBAN BROWN | STRIP



BEYOND RETRO COLLECTION | URBAN BROWN | PLANK

BEYOND RETRO COLLECTION

URBAN BROWN

A. Strip: 153N6BEKP4KW240
 B. Plank: 151N9AEKP4KW200

- Design:** Plank & 3-Strip Options
- Features:** All: Oak, Stained, Brushed
 Plank: 4-Side Micro Bevel
 Strip: Straight Edge
- Surface Treatment:** Ultra Matte Finish (UV-Cured Acrylic)
- Wear Layer:** Approx. 3.5mm
- Grading:** Plank: Dynamic
 Strip: Lively
- Joint:** Woodloc® 5S
- Guarantee:** Lifetime Structural
 25 Year Wear Through
- Installation:** Float, Glue-down, Nail-down
This product may be floated over radiant heat.

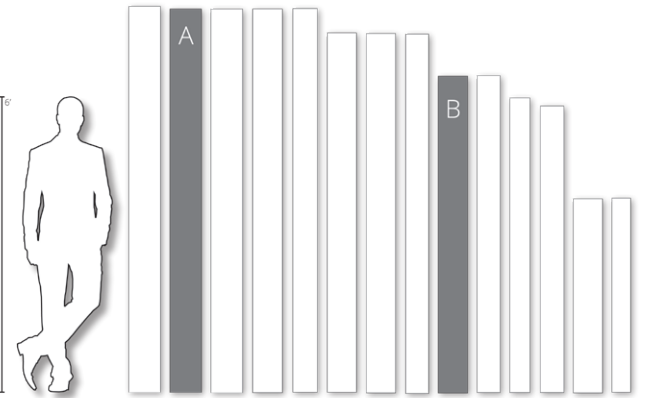

	Length	Width	Thickness	Boards/Ctn	Area	Weight	Ctn/Pallet	Pallets/Cont.
A. Strip	95 3/8"	7 7/8"	5/8"	6	31.324ft ²	54lbs	50	16
B. Plank	78 3/4"	7 3/8"	5/8"	6	24.111ft ²	40lbs	45	16



URBAN BROWN | STRIP



BEYOND RETRO COLLECTION | CHARCOAL LIGHT | STRIP



BEYOND RETRO COLLECTION | CHARCOAL LIGHT | PLANK

BEYOND RETRO COLLECTION

CHARCOAL LIGHT

A. Strip: 153N6BEKS4KW240
 B. Plank: 151N9AEKS4KW200

- Design:** Plank & 3-Strip Options
- Features:** All: Oak, Stained, Brushed
 Plank: 4-Side Micro Bevel
 Strip: Straight Edge
- Surface Treatment:** Ultra Matte Finish (UV-Cured Acrylic)
- Wear Layer:** Approx. 3.5mm
- Grading:** Plank: Dynamic
 Strip: Lively
- Joint:** Woodloc® 5S
- Guarantee:** Lifetime Structural
 25 Year Wear Through
- Installation:** Float, Glue-down, Nail-down
This product may be floated over radiant heat.

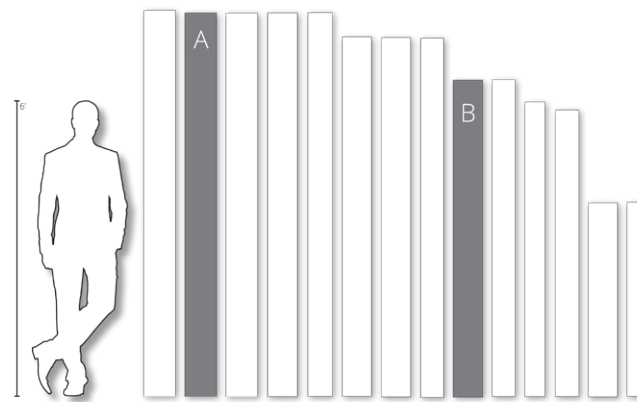

	Length	Width	Thickness	Boards/Ctn	Area	Weight	Ctn/Pallet	Pallets/Cont.
A. Strip	95 3/8"	7 7/8"	5/8"	6	31.324ft ²	54lbs	50	16
B. Plank	78 3/4"	7 3/8"	5/8"	6	24.111ft ²	40lbs	45	16



CHARCOAL LIGHT | PLANK



BEYOND RETRO COLLECTION | FROSTED OAT | STRIP



BEYOND RETRO COLLECTION | FROSTED OAT | PLANK

BEYOND RETRO COLLECTION

FROSTED OAT

A. Strip: 153N6BEKN4KW240
 B. Plank: 151N9AEKN4KW200

- Design:** Plank & 3-Strip Options
- Features:** All: Oak, Stained, Brushed
 Plank: 4-Side Micro Bevel
 Strip: Straight Edge
- Surface Treatment:** Ultra Matte Finish (UV-Cured Acrylic)
- Wear Layer:** Approx. 3.5mm
- Grading:** Plank: Dynamic
 Strip: Lively
- Joint:** Woodloc® 5S
- Guarantee:** Lifetime Structural
 25 Year Wear Through
- Installation:** Float, Glue-down, Nail-down
This product may be floated over radiant heat.

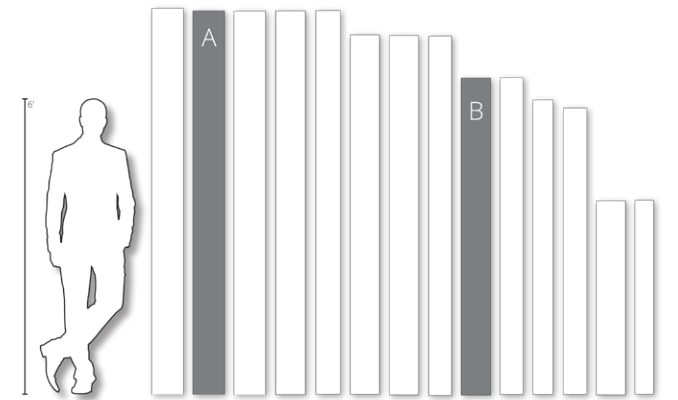

	Length	Width	Thickness	Boards/Ctn	Area	Weight	Ctn/Pallet	Pallets/Cont.
A. Strip	95 3/8"	7 7/8"	5/8"	6	31.324ft ²	54lbs	50	16
B. Plank	78 3/4"	7 3/8"	5/8"	6	24.111ft ²	40lbs	45	16



FROSTED OAT | STRIP



BEYOND RETRO COLLECTION | FROZEN HAZELNUT | STRIP

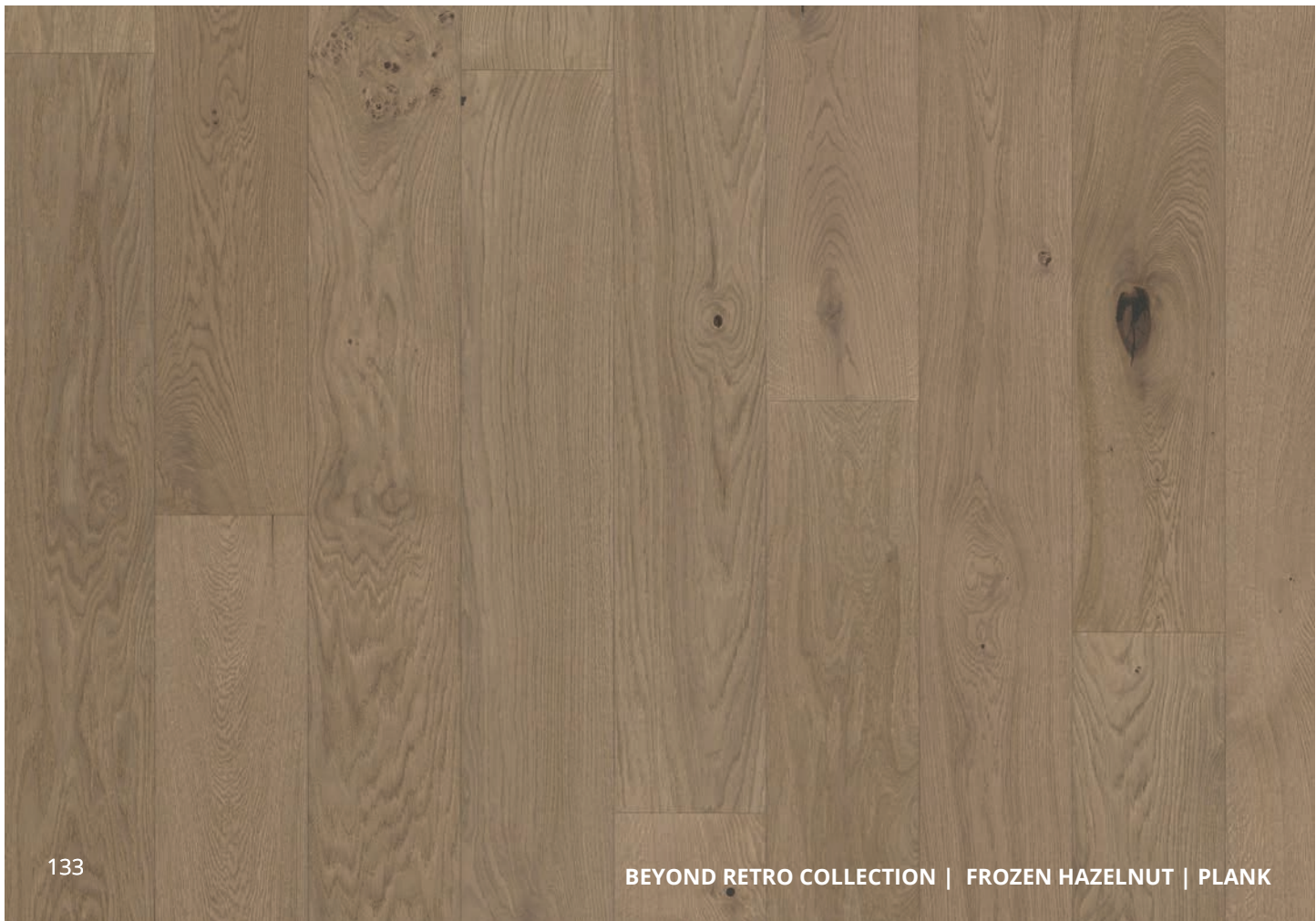

BEYOND RETRO COLLECTION | FROZEN HAZELNUT | PLANK

BEYOND RETRO COLLECTION

FROZEN HAZELNUT

A. Strip: 153N6BEKQ4KW240
 B. Plank: 151N9AEKQ4KW200

- Design:** Plank & 3-Strip Options
- Features:** All: Oak, Stained, Brushed
 Plank: 4-Side Micro Bevel
 Strip: Straight Edge
- Surface Treatment:** Ultra Matte Finish (UV-Cured Acrylic)
- Wear Layer:** Approx. 3.5mm
- Grading:** Plank: Dynamic
 Strip: Lively
- Joint:** Woodloc® 5S
- Guarantee:** Lifetime Structural
 25 Year Wear Through
- Installation:** Float, Glue-down, Nail-down
This product may be floated over radiant heat.

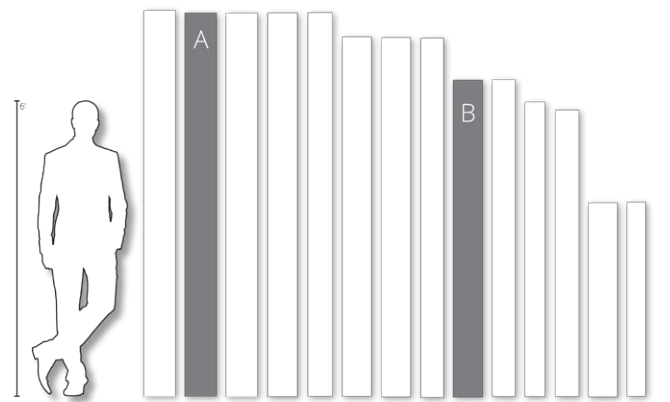

	Length	Width	Thickness	Boards/Ctn	Area	Weight	Ctn/Pallet	Pallets/Cont.
A. Strip	95 3/8"	7 7/8"	5/8"	6	31.324ft ²	54lbs	50	16
B. Plank	78 3/4"	7 3/8"	5/8"	6	24.111ft ²	40lbs	45	16



FROZEN HAZELNUT | PLANK



TEXTURE COLLECTION



TEXTURE NATUR

TEXTURE COLLECTION

This collection of engineered Oak floors is designed to let the raw beauty of nature speak for itself. With a focus on maintaining all the inherent features of wood, the design of Texture lies in the natural details and contrasts. Soft saw marks and a matte oil finish further emphasize the naturally occurring design details and enhance the natural character of the material.

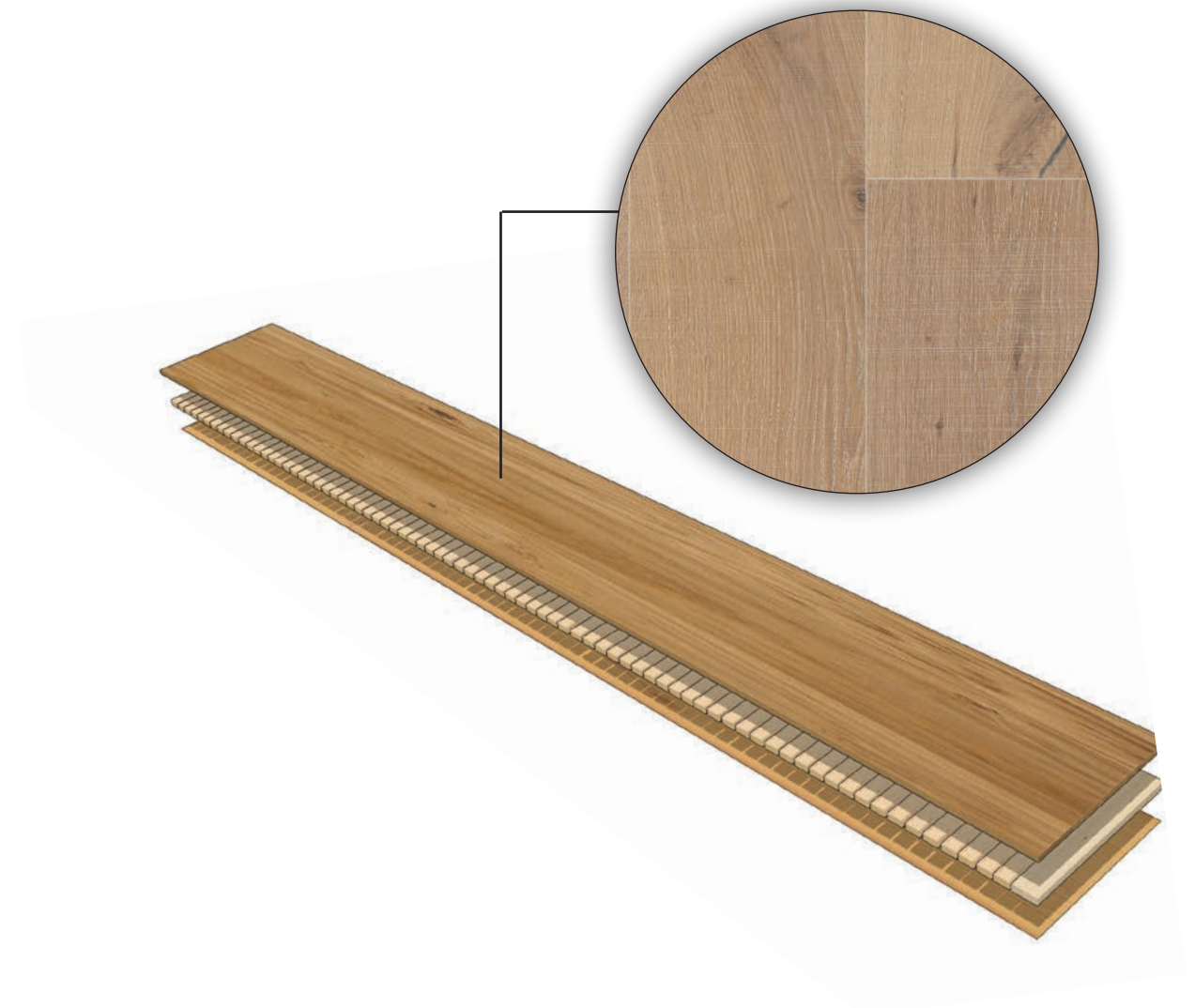



TEXTURE COLLECTION

TEXTURE GRAU

151200240

- Design:** Plank
- Features:** Oak, Brushed, Micro Beveled, Saw Marks, Smoked
- Surface Treatment:** Oil
- Grading:** Expressive
- Wear Layer:** Approx 3.5mm (1/8")
- Joint:** Woodloc® 5S
- Guarantee:** Lifetime Structural
- Installation:** Float, Glue-down, Nail-down

This product may be floated over radiant heat.

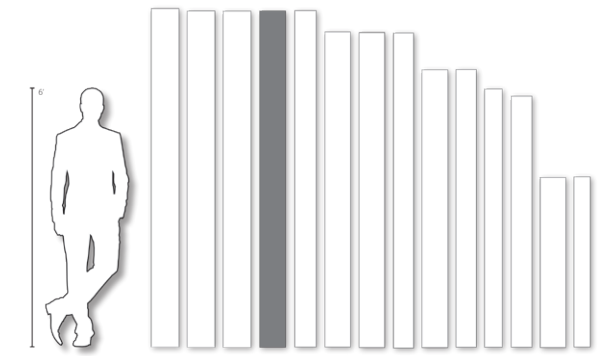

Length	Width	Thickness	Boards/Ctn	Area	Weight	Ctn/Pallet	Pallets/Cont.
95 1/4"	7 3/8"	5/8"	6	29.279ft ²	49lbs	50	16



This product must be oiled immediately after installation and prior to use.





TEXTURE COLLECTION

TEXTURE NATUR

151198240

- Design:** Plank
 - Features:** Oak, Brushed, Micro Beveled, Saw Marks
 - Surface Treatment:** Oil
 - Grading:** Expressive
 - Wear Layer:** Approx 3.5mm (1/8")
 - Joint:** Woodloc® 5S
 - Guarantee:** Lifetime Structural
 - Installation:** Float, Glue-down, Nail-down
- This product may be floated over radiant heat.*

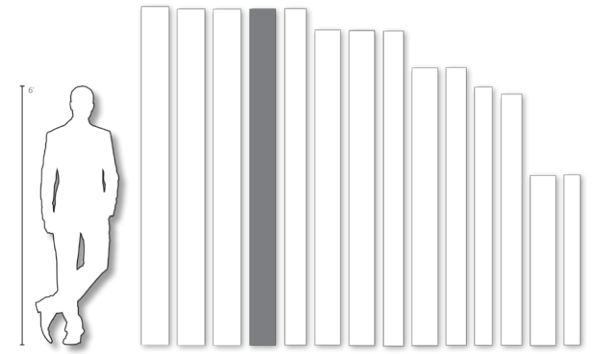

Length	Width	Thickness	Boards/Ctn	Area	Weight	Ctn/Pallet	Pallets/Cont.
95 1/4"	7 3/8"	5/8"	6	29.279ft ²	49lbs	50	16



This product must be oiled immediately after installation and prior to use.





TEXTURE COLLECTION

TEXTURE ROHOPTIC

151201240

- Design:** Plank
 - Features:** Oak, Brushed, Micro Beveled, Saw Marks, Stained
 - Surface Treatment:** Oil
 - Grading:** Expressive
 - Wear Layer:** Approx 3.5mm (1/8")
 - Joint:** Woodloc® 5S
 - Guarantee:** Lifetime Structural
 - Installation:** Float, Glue-down, Nail-down
- This product may be floated over radiant heat.*

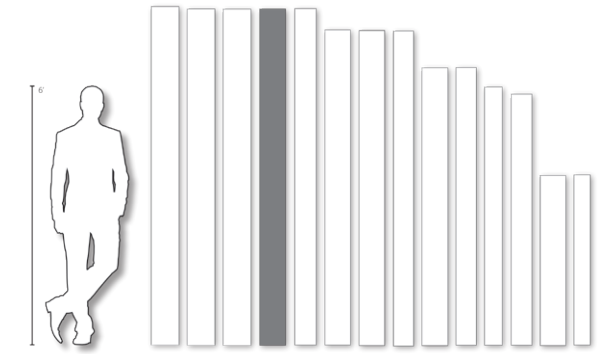

Length	Width	Thickness	Boards/Ctn	Area	Weight	Ctn/Pallet	Pallets/Cont.
95 1/4"	7 3/8"	5/8"	6	29.279ft²	49lbs	50	16



This product must be oiled immediately after installation and prior to use.





TEXTURE COLLECTION

TEXTURE WEISS

151199240

- Design:** Plank
- Features:** Oak, Brushed, Micro Beveled, Saw Marks, Stained
- Surface Treatment:** Oil
- Grading:** Expressive
- Wear Layer:** Approx 3.5mm (1/8")
- Joint:** Woodloc® 5S
- Guarantee:** Lifetime Structural
- Installation:** Float, Glue-down, Nail-down

This product may be floated over radiant heat.

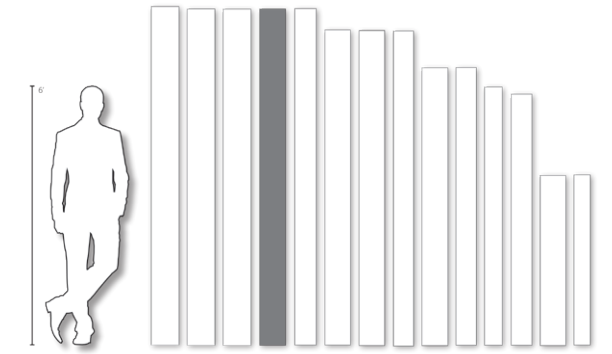

Length	Width	Thickness	Boards/Ctn	Area	Weight	Ctn/Pallet	Pallets/Cont.
95 1/4"	7 3/8"	5/8"	6	29.279ft²	49lbs	50	16



This product must be oiled immediately after installation and prior to use.





OAK HORIZON

LUX
COLLECTION



OAK BISCOTTI

LUX COLLECTION: 6" WIDE PLANKS

The Lux Collection features floors with the look and feel of untreated, newly-sawn timber. This is achieved through an ultra-matte surface treatment. Featuring a four-sided micro bevel, these floors achieve the classic wide plank look. Biscotti, Ghost, Eggshell, and Crayon are 6" in width, while the other Lux products are 7 3/8" wide.





LUX COLLECTION

OAK EGGSHELL

151N51EKC4KW240

- Design:** Plank
- Features:** European Oak, Brushed, Micro Beveled Edges
- Surface Treatment:** Ultra Matte Finish (UV-Cured Acrylic)
- Wear Layer:** Approx. 3.5mm (1/8")
- Grading:** Lively
- Joint:** Woodloc® 5S
- Guarantee:** Lifetime Structural
25 Year Wear Through
- Installation:** Float, Glue-down, Nail-down

This product may be floated over radiant heat.

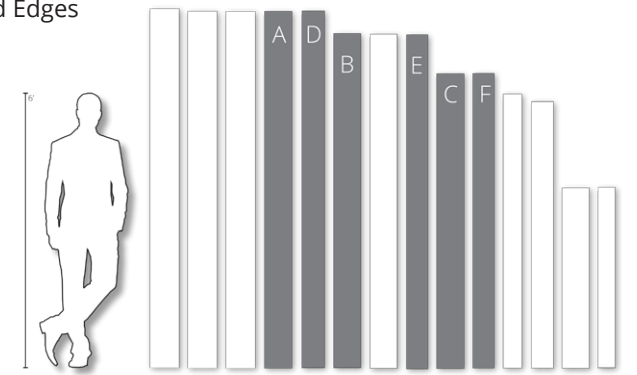

	Length	Width	Thickness	Boards/Ctn	Area	Weight	Ctn/Pallet	Pallets/Cont.
Pattern D	95 1/4"	6"	5/8"	6	23.681ft ²	40	54	16

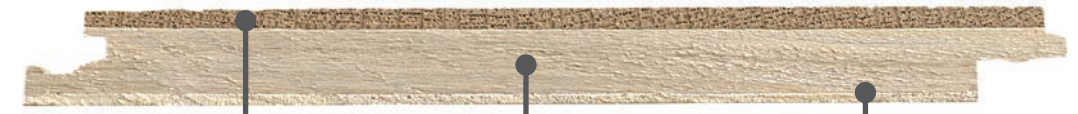

3-Layer Construction:

Surface layer: sawn plank.

Solid pine fingers.

Bottom layer of poplar veneer.





LUX COLLECTION

OAK GHOST

151N51EKB4KW240

- Design:** Plank
- Features:** European Oak, Brushed, Micro Beveled Edges
- Surface Treatment:** Ultra Matte Finish (UV-Cured Acrylic)
- Wear Layer:** Approx. 3.5mm (1/8")
- Grading:** Lively
- Joint:** Woodloc® 5S
- Guarantee:** Lifetime Structural
25 Year Wear Through
- Installation:** Float, Glue-down, Nail-down

This product may be floated over radiant heat.

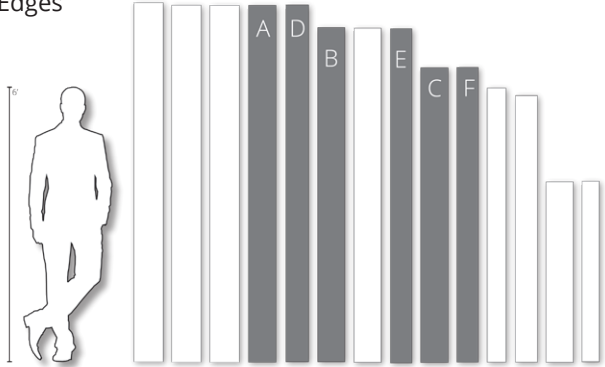

	Length	Width	Thickness	Boards/Ctn	Area	Weight	Ctn/Pallet	Pallets/Cont.
Pattern D	95 1/4"	6"	5/8"	6	23.681ft ²	40	54	16





LUX COLLECTION

OAK CRAYON

151N51EKL4KW240

- Design:** Plank
- Features:** European Oak, Brushed, Micro Beveled Edges
- Surface Treatment:** Ultra Matte Finish (UV-Cured Acrylic)
- Wear Layer:** Approx. 3.5mm (1/8")
- Grading:** Lively
- Joint:** Woodloc® 5S
- Guarantee:** Lifetime Structural
25 Year Wear Through
- Installation:** Float, Glue-down, Nail-down

This product may be floated over radiant heat.

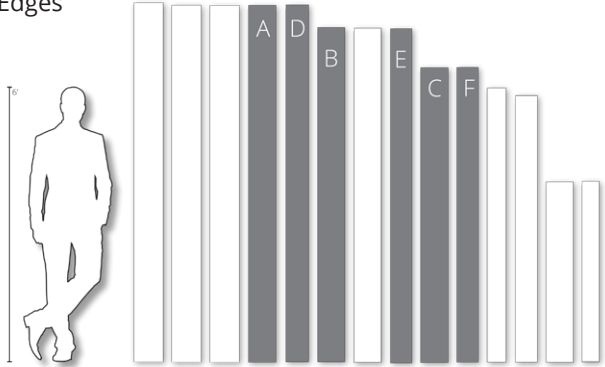

	Length	Width	Thickness	Boards/Ctn	Area	Weight	Ctn/Pallet	Pallets/Cont.
Pattern D	95 1/4"	6"	5/8"	6	23.681ft ²	40	54	16





LUX COLLECTION

OAK BISCOTTI

- Design:** Plank
 - Features:** European Oak, Brushed, Micro Beveled Edges
 - Surface Treatment:** Ultra Matte Finish (UV-Cured Acrylic)
 - Wear Layer:** Approx. 3.5mm (1/8")
 - Grading:** Lively
 - Joint:** Woodloc® 5S
 - Guarantee:** Lifetime Structural
25 Year Wear Through
 - Installation:** Float, Glue-down, Nail-down
- This product may be floated over radiant heat.*

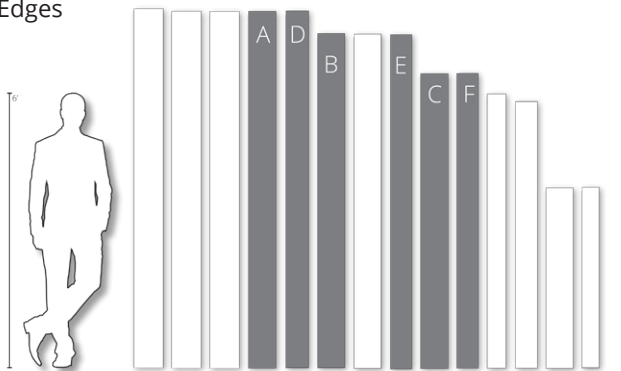

(E) 151N51EKK4KW220
(F) 151N51EKK4KW200

	Length	Width	Thickness	Boards/Ctn	Area	Weight	Ctn/Pallet	Pallets/Cont.
Pattern E	89 1/4"	6"	5/8"	6	22.066ft ²	37	54	16
Pattern F	78 3/4"	6"	5/8"	6	19.482ft ²	33	54	16



LUX COLLECTION | *SPECIAL ORDER*

The Lux Collection features floors with the look and feel of untreated, newly-sawn timber. This is achieved through an ultra-matte surface treatment. Featuring a four-sided micro bevel, these floors achieve the classic wide plank look, in colors ranging from light to dark. The innovative surface treatment is non-reflective, enhancing the color of the floor while giving it a silky, yet strong shield against wear-and-tear.



ASH STREAM



LUX COLLECTION

ASH FLOW | SPECIAL ORDER

151N8AAKG4KW240

- Design:** Plank
- Features:** Scandinavian Ash, Stained, Brushed, Micro Beveled Edges
- Surface Treatment:** Ultra Matte Finish (UV-Cured Acrylic)
- Wear Layer:** Approx. 3.5mm (1/8")
- Grading:** Lively
- Joint:** Woodloc® 5S
- Guarantee:** Lifetime Structural
25 Year Wear Through
- Installation:** Float, Glue-down, Nail-down

This product may be floated over radiant heat.

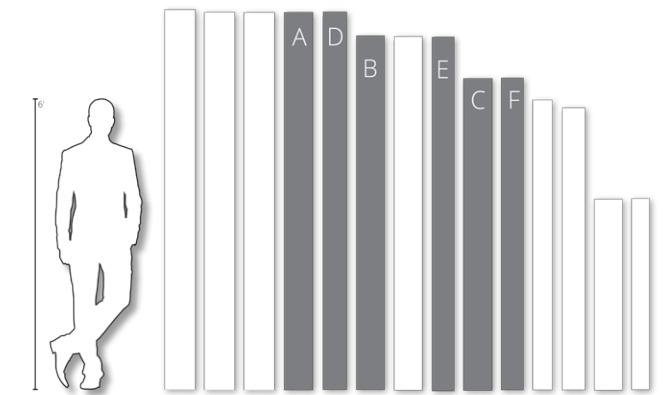

	Length	Width	Thickness	Boards/Ctn	Area	Weight	Ctn/Pallet	Pallets/Cont.
Pattern A	95 1/4"	7 3/8"	5/8"	6	29.279ft²	49lbs	50	16





LUX COLLECTION

OAK AURORA | SPECIAL ORDER

151N9AEKC4KW220

- Design:** Plank
- Features:** European Oak, Brushed, Stained, Micro Beveled Edges
- Surface Treatment:** Ultra Matte Finish (UV-Cured Acrylic)
- Wear Layer:** Approx. 3.5mm (1/8")
- Grading:** Dynamic
- Joint:** Woodloc® 5S
- Guarantee:** Lifetime Structural
25 Year Wear Through
- Installation:** Float, Glue-down, Nail-down

This product may be floated over radiant heat.

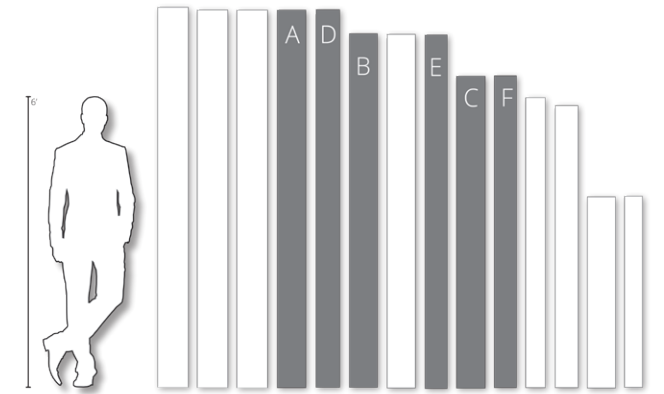

	Length	Width	Thickness	Boards/Ctn	Area	Weight	Ctn/Pallet	Pallets/Cont.
Pattern B	89 1/4"	7 3/8"	5/8"	6	27.341ft ²	47lbs	50	16





LUX COLLECTION

OAK COAST | SPECIAL ORDER

151N8AEKD4KW200

- Design:** Plank
- Features:** European Oak, Brushed, Stained, Micro Beveled Edges
- Surface Treatment:** Ultra Matte Finish (UV-Cured Acrylic)
- Wear Layer:** Approx. 3.5mm (1/8")
- Grading:** Lively
- Joint:** Woodloc® 5S
- Guarantee:** Lifetime Structural
25 Year Wear Through
- Installation:** Float, Glue-down, Nail-down

This product may be floated over radiant heat.

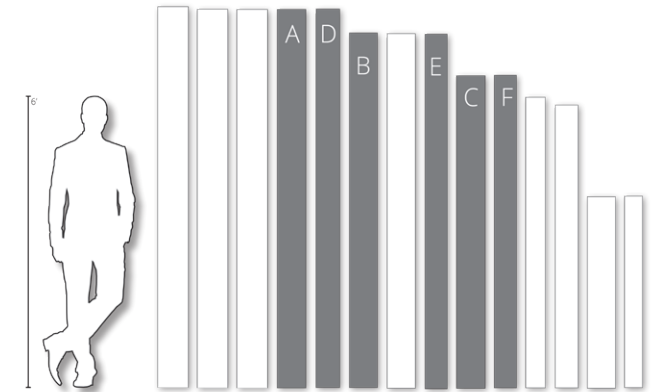

	Length	Width	Thickness	Boards/Ctn	Area	Weight	Ctn/Pallet	Pallets/Cont.
Pattern C	78 3/4"	7 3/8"	5/8"	6	24.111ft ²	45lbs	50	16





LUX COLLECTION

OAK HORIZON | SPECIAL ORDER

151N8AEKC4KW240

- Design:** Plank
- Features:** European Oak, Brushed, Stained, Micro Beveled Edges
- Surface Treatment:** Ultra Matte Finish (UV-Cured Acrylic)
- Wear Layer:** Approx. 3.5mm (1/8")
- Grading:** Lively
- Joint:** Woodloc® 5S
- Guarantee:** Lifetime Structural
25 Year Wear Through
- Installation:** Float, Glue-down, Nail-down

This product may be floated over radiant heat.

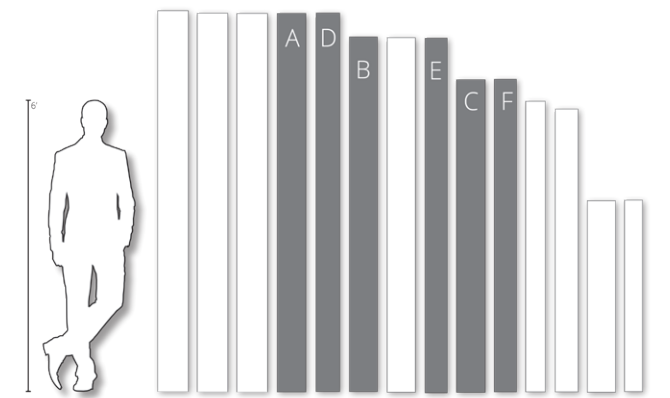

	Length	Width	Thickness	Boards/Ctn	Area	Weight	Ctn/Pallet	Pallets/Cont.
Pattern A	95 1/4"	7 3/8"	5/8"	6	29.279ft ²	49lbs	50	16





LUX COLLECTION

OAK RISE | SPECIAL ORDER

151N9AEK04KW220

- Design:** Plank
- Features:** European Oak, Brushed, Micro Beveled Edges
- Surface Treatment:** Ultra Matte Finish (UV-Cured Acrylic)
- Wear Layer:** Approx. 3.5mm (1/8")
- Grading:** Dynamic
- Joint:** Woodloc® 5S
- Guarantee:** Lifetime Structural
25 Year Wear Through
- Installation:** Float, Glue-down, Nail-down

This product may be floated over radiant heat.

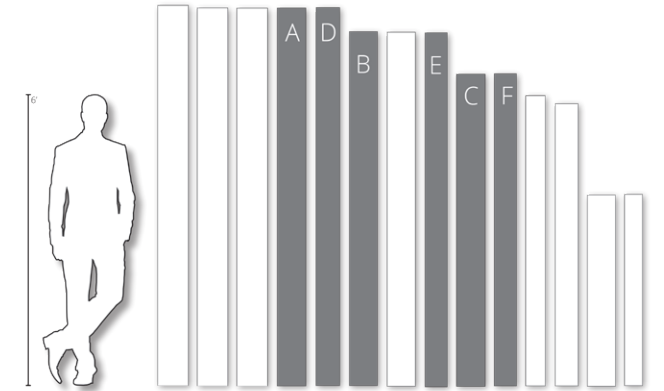

	Length	Width	Thickness	Boards/Ctn	Area	Weight	Ctn/Pallet	Pallets/Cont.
Pattern B	89 1/4"	7 3/8"	5/8"	6	27.341ft ²	47lbs	50	16





LUX COLLECTION

OAK SHORE | SPECIAL ORDER

151N8AEKE4KW240

- Design:** Plank
- Features:** European Oak, Brushed, Stained, Micro Beveled Edges
- Surface Treatment:** Ultra Matte Finish (UV-Cured Acrylic)
- Wear Layer:** Approx. 3.5mm (1/8")
- Grading:** Lively
- Joint:** Woodloc® 5S
- Guarantee:** Lifetime Structural
25 Year Wear Through
- Installation:** Float, Glue-down, Nail-down

This product may be floated over radiant heat.

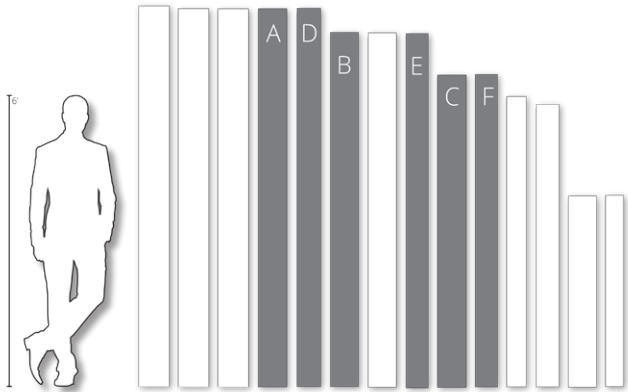

	Length	Width	Thickness	Boards/Ctn	Area	Weight	Ctn/Pallet	Pallets/Cont.
Pattern A	95 1/4"	7 3/8"	5/8"	6	29.279ft ²	49lbs	50	16





LUX COLLECTION

OAK SKY | SPECIAL ORDER

151N8AEKE4KW240

- Design:** Plank
- Features:** European Oak, Brushed, Stained, Micro Beveled Edges
- Surface Treatment:** Ultra Matte Finish (UV-Cured Acrylic)
- Wear Layer:** Approx. 3.5mm (1/8")
- Grading:** Lively
- Joint:** Woodloc® 5S
- Guarantee:** Lifetime Structural
25 Year Wear Through
- Installation:** Float, Glue-down, Nail-down

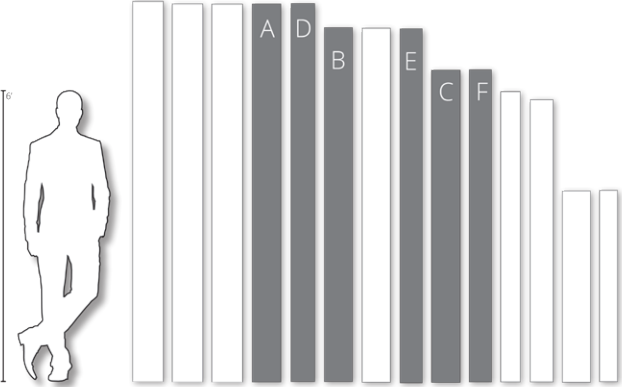

This product may be floated over radiant heat.

	Length	Width	Thickness	Boards/Ctn	Area	Weight	Ctn/Pallet	Pallets/Cont.
Pattern A	95 1/4"	7 3/8"	5/8"	6	29.279ft ²	49lbs	50	16





LUX COLLECTION

OAK SUN | SPECIAL ORDER

151N8AEK04KW240

- Design:** Plank
- Features:** European Oak, Brushed, Micro Beveled Edges
- Surface Treatment:** Ultra Matte Finish (UV-Cured Acrylic)
- Wear Layer:** Approx. 3.5mm (1/8")
- Grading:** Lively
- Joint:** Woodloc® 5S
- Guarantee:** Lifetime Structural
25 Year Wear Through
- Installation:** Float, Glue-down, Nail-down

This product may be floated over radiant heat.

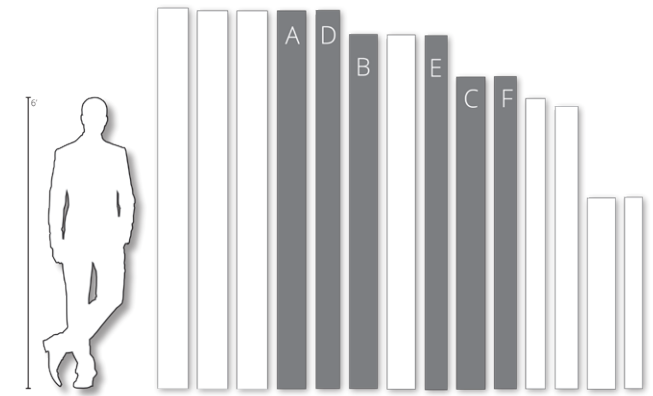

	Length	Width	Thickness	Boards/Ctn	Area	Weight	Ctn/Pallet	Pallets/Cont.
Pattern A	95 1/4"	7 3/8"	5/8"	6	29.279ft ²	49lbs	50	16





LUX COLLECTION

OAK TERRA | SPECIAL ORDER

151N8AEKF4KW240

- Design:** Plank
- Features:** European Oak, Brushed, Smoked, Micro Beveled Edges
- Surface Treatment:** Ultra Matte Finish (UV-Cured Acrylic)
- Wear Layer:** Approx. 3.5mm (1/8")
- Grading:** Lively
- Joint:** Woodloc® 5S
- Guarantee:** Lifetime Structural
25 Year Wear Through
- Installation:** Float, Glue-down, Nail-down

This product may be floated over radiant heat.

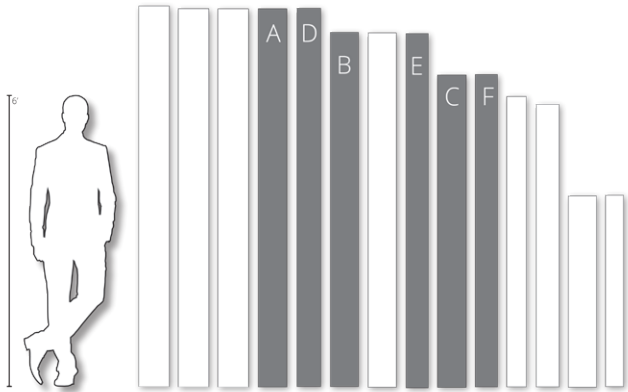

	Length	Width	Thickness	Boards/Ctn	Area	Weight	Ctn/Pallet	Pallets/Cont.
Pattern A	95 1/4"	7 3/8"	5/8"	6	29.279ft²	49lbs	50	16





LUX COLLECTION

ASH STREAM | SPECIAL ORDER

151N8AAKH4KW240

- Design:** Plank
- Features:** Scandinavian Ash, Brushed, Stained, Micro Beveled Edges
- Surface Treatment:** Ultra Matte Finish (UV-Cured Acrylic)
- Wear Layer:** Approx. 3.5mm (1/8")
- Grading:** Lively
- Joint:** Woodloc® 5S
- Guarantee:** Lifetime Structural
25 Year Wear Through
- Installation:** Float, Glue-down, Nail-down

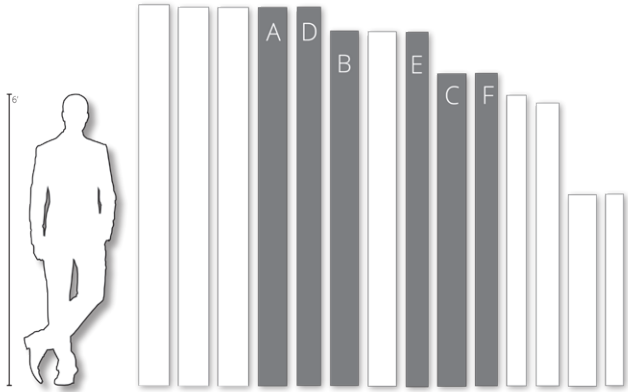

This product may be floated over radiant heat.

	Length	Width	Thickness	Boards/Ctn	Area	Weight	Ctn/Pallet	Pallets/Cont.
Pattern A	95 1/4"	7 3/8"	5/8"	6	29.279ft ²	49lbs	50	16





CAPITAL COLLECTION



OAK DUBLIN

CAPITAL COLLECTION | *SPECIAL ORDER*

The Capital Collection features long, wide boards with a clean grade. Only our finest oak is selected for this exclusive product range of plank floors, named for the prestigious capital cities from around the world.





CAPITAL COLLECTION

OAK BERLIN | SPECIAL ORDER

151N4AEKFMKW220

- Design:** Plank
- Features:** European Oak, Brushed, Smoked, Micro Beveled Edges
- Surface Treatment:** Oil
- Wear Layer:** Approx. 3.5mm (1/8")
- Grading:** Calm
- Joint:** Woodloc® 5S
- Guarantee:** Lifetime Structural
- Installation:** Float, Glue-down, Nail-down

This product may be floated over radiant heat.

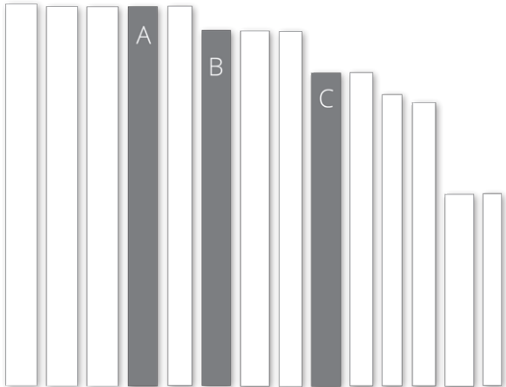

	Length	Width	Thickness	Boards/Ctn	Area	Weight	Ctn/Pallet	Pallets/Cont.
Pattern B	89 1/4"	7 3/8"	5/8"	6	27.341ft ²	47bs	50	16



3-Layer Construction:

Surface layer: sawn plank.

Solid pine fingers.

Bottom layer of poplar veneer.

This product must be oiled immediately after installation and prior to use.





CAPITAL COLLECTION

OAK DUBLIN | SPECIAL ORDER

151N4AEK04KW240

- Design:** Plank
- Features:** European Oak, Brushed, Micro Beveled Edges
- Surface Treatment:** Ultra Matte Finish (UV-Cured Acrylic)
- Wear Layer:** Approx. 3.5mm (1/8")
- Grading:** Calm
- Joint:** Woodloc® 5S
- Guarantee:** Lifetime Structural
25 Year Wear Through
- Installation:** Float, Glue-down, Nail-down

This product may be floated over radiant heat.

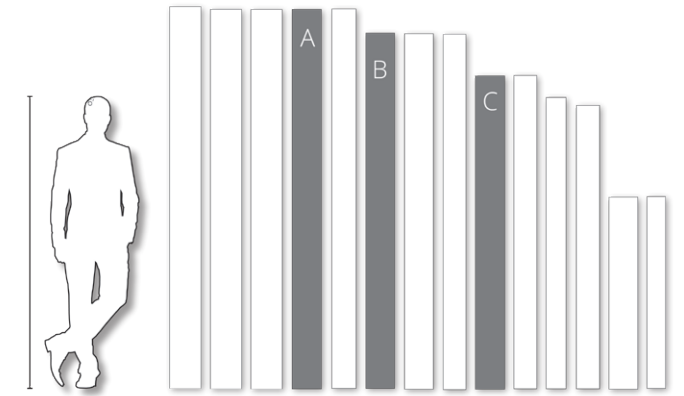

	Length	Width	Thickness	Boards/Ctn	Area	Weight	Ctn/Pallet	Pallets/Cont.
Pattern A	95 1/4"	7 3/8"	5/8"	6	29.279ft ²	49lbs	50	16





CAPITAL COLLECTION

OAK PARIS | SPECIAL ORDER

- Design:** Plank
- Features:** European Oak, Stained, Brushed, Micro Beveled Edges
- Surface Treatment:** Ultra Matte Finish (UV-Cured Acrylic)
- Wear Layer:** Approx. 3.5mm (1/8")
- Grading:** Calm
- Joint:** Woodloc® 5S
- Guarantee:** Lifetime Structural
25 Year Wear Through
- Installation:** Float, Glue-down, Nail-down

This product may be floated over radiant heat.

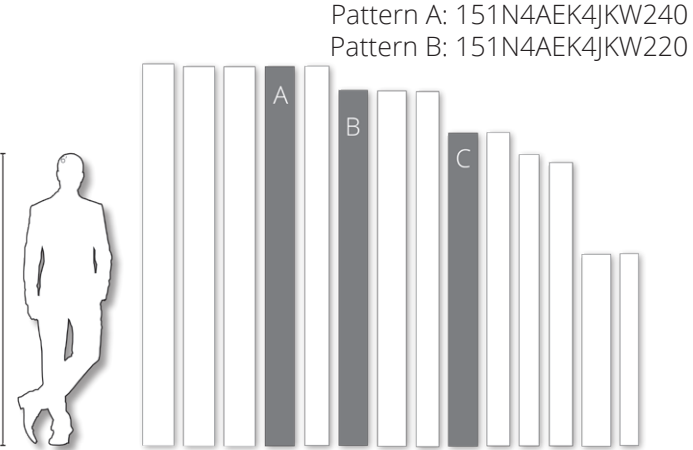

	Length	Width	Thickness	Boards/Ctn	Area	Weight	Ctn/Pallet	Pallets/Cont.
Pattern A	95 1/4"	7 3/8"	5/8"	6	29.279 ft2	49 lbs	50	16
Pattern B	89 1/4"	7 3/8"	5/8"	6	27.341 ft2	47 lbs	50	16

**SKUs vary in availability. Please reach out to your Kährs rep for details.*





CAPITAL COLLECTION

OAK PRAGUE | SPECIAL ORDER

151N4AEKD4KW200

- Design:** Plank
- Features:** European Oak, Brushed, Stained, Micro Beveled Edge
- Surface Treatment:** Ultra Matte Finish (UV-Cured Acrylic)
- Wear Layer:** Approx. 3.5mm (1/8")
- Grading:** Calm
- Joint:** Woodloc® 5S
- Guarantee:** Lifetime Structural
25 Year Wear Through
- Installation:** Float, Glue-down, Nail-down

This product may be floated over radiant heat.

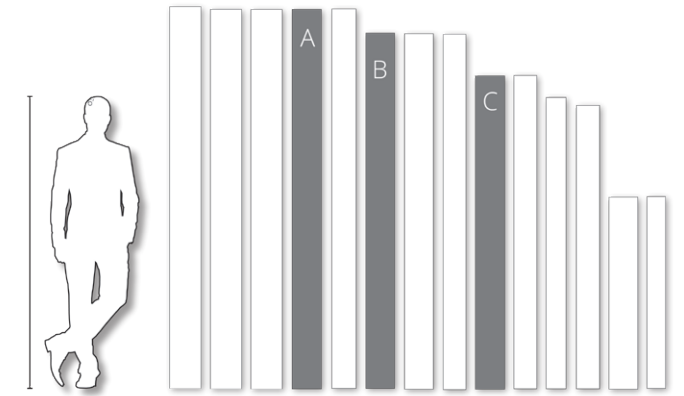

	Length	Width	Thickness	Boards/Ctn	Area	Weight	Ctn/Pallet	Pallets/Cont.
Pattern C	78 3/4"	7 3/8"	5/8"	6	24.111ft ²	45lbs	50	16





HARMONY & SAND COLLECTIONS



OAK CIRRUS

HARMONY & SAND COLLECTIONS

Harmony: the comfort of home, with its warm, nurturing atmosphere. A place to retreat, awash with mellow tones that calm the body and soul. The subtle, rich tones of Kährs Harmony and Sand Collections are designed to complement all interior styles and to create a sense of well-being.





HARMONY COLLECTION

OAK CREME

152N7BEK0WKW 0

- Design:** 2-Strip
- Features:** Brushed European Oak, Stained, Square Edge
- Surface Treatment:** Matte Finish (UV-Cured Acrylic)
- Wear Layer:** Approx. 3.5mm (1/8")
- Grading:** Variation
- Joint:** Woodloc® 5S
- Guarantee:** Lifetime Structural
25 Year Wear Through
- Installation:** Float, Glue-down, Nail-down

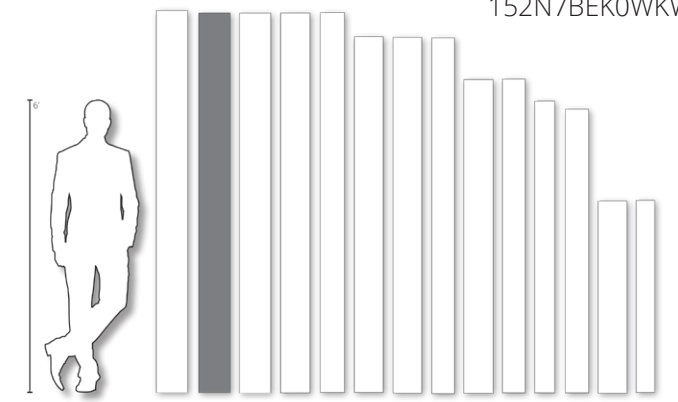

This product may be floated over radiant heat.

Length	Width	Thickness	Boards/Ctn	Area	Weight	Ctn/Pallet	Pallets/Cont.
95 3/8"	7 7/8"	5/8"	6	31.324ft ²	54lbs	50	16



3-Layer Construction:

Surface layer consists of sawn strips.

Solid pine fingers.

Bottom layer of poplar veneer.





HARMONY COLLECTION

OAK GRANITE

152N6REKGGKW 0

- Design:** 2-Strip
 - Features:** Brushed European Oak, Stained, Lightly Smoked, Square Edge
 - Surface Treatment:** Matte Finish (UV-Cured Acrylic)
 - Wear Layer:** Approx. 3.5mm (1/8")
 - Grading:** Lively
 - Joint:** Woodloc® 5S
 - Guarantee:** Lifetime Structural
25 Year Wear Through
 - Installation:** Float, Glue-down, Nail-down
- This product may be floated over radiant heat.*

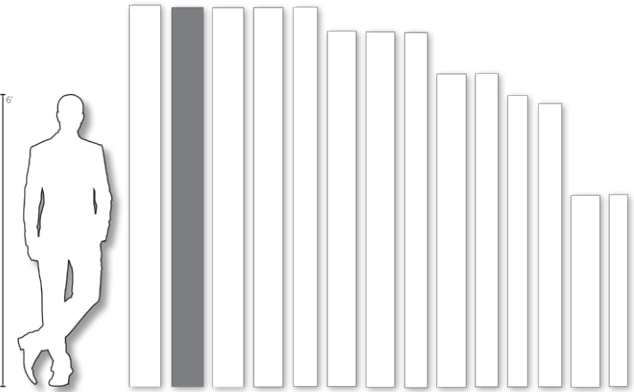

Length	Width	Thickness	Boards/Ctn	Area	Weight	Ctn/Pallet	Pallets/Cont.
95 3/8"	7 7/8"	5/8"	6	31.324ft²	54lbs	50	16



3-Layer Construction:
 Surface layer consists of sawn strips. Solid pine fingers. Bottom layer of poplar veneer.





HARMONY COLLECTION

OAK CIRRUS

152N2BEKWKW 0

- Design:** 2-Strip
 - Features:** Brushed European Oak, Stained, Square Edge
 - Surface Treatment:** Matte Finish (UV-Cured Acrylic)
 - Wear Layer:** Approx. 3.5mm (1/8")
 - Grading:** Lively
 - Joint:** Woodloc® 5S
 - Guarantee:** Lifetime Structural
25 Year Wear Through
 - Installation:** Float, Glue-down, Nail-down
- This product may be floated over radiant heat.*

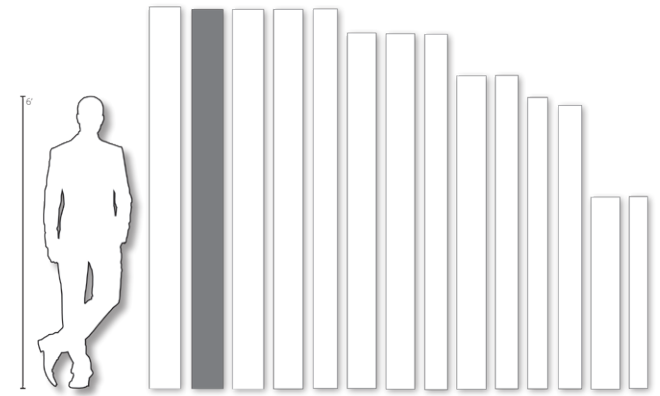

Length	Width	Thickness	Boards/Ctn	Area	Weight	Ctn/Pallet	Pallets/Cont.
95 3/8"	7 7/8"	5/8"	6	31.324ft ²	54lbs	50	16



3-Layer Construction:

Surface layer consists of sawn strips.

Solid pine fingers.

Bottom layer of poplar veneer.





HARMONY COLLECTION

OAK LAVA

153N6CEK1JKW 0

- Design:** 3-Strip
 - Features:** Brushed European Oak, Stained, Square Edge
 - Surface Treatment:** Matte Finish (UV-Cured Acrylic)
 - Wear Layer:** Approx. 3.5mm (1/8")
 - Grading:** Lively
 - Joint:** Woodloc® 5S
 - Guarantee:** Lifetime Structural
25 Year Wear Through
 - Installation:** Float, Glue-down, Nail-down
- This product may be floated over radiant heat.*

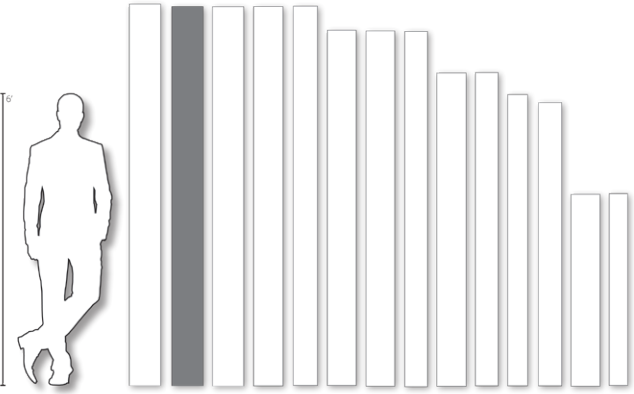

Length	Width	Thickness	Boards/Ctn	Area	Weight	Ctn/Pallet	Pallets/Cont.
95 3/8"	7 7/8"	5/8"	6	31.324ft ²	54lbs	50	16



3-Layer Construction:
 Surface layer consists of sawn strips. Solid pine fingers. Bottom layer of poplar veneer.





HARMONY COLLECTION

OAK ALLOY

153N0BEKD1KW 0

- Design:** 3-Strip
 - Features:** Brushed European Oak, Stained, Square Edge
 - Surface Treatment:** Matte Finish (UV-Cured Acrylic)
 - Wear Layer:** Approx. 3.5mm (1/8")
 - Grading:** Lively
 - Joint:** Woodloc® 5S
 - Guarantee:** Lifetime Structural
25 Year Wear Through
 - Installation:** Float, Glue-down, Nail-down
- This product may be floated over radiant heat.*

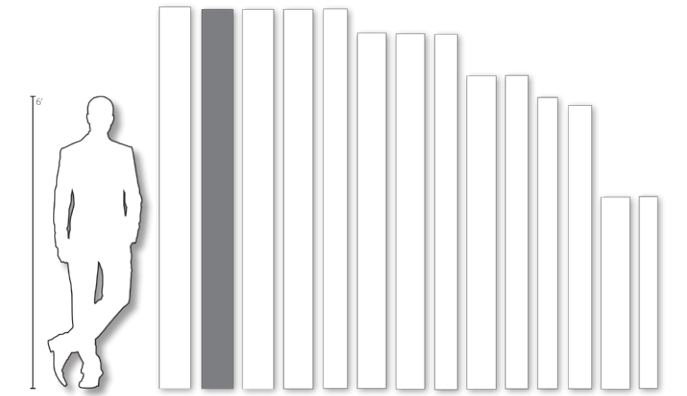

Length	Width	Thickness	Boards/Ctn	Area	Weight	Ctn/Pallet	Pallets/Cont.
95 3/8"	7 7/8"	5/8"	6	31.324ft ²	54lbs	50	16



3-Layer Construction:
 Surface layer consists of sawn strips. Solid pine fingers. Bottom layer of poplar veneer.





HARMONY COLLECTION

OAK PALE

153N5BEKP1KW 0

- Design:** 3-Strip
 - Features:** Brushed European Oak, Stained, Square Edge
 - Surface Treatment:** Matte Finish (UV-Cured Acrylic)
 - Wear Layer:** Approx. 3.5mm (1/8")
 - Grading:** Variation
 - Joint:** Woodloc® 5S
 - Guarantee:** Lifetime Structural
25 Year Wear Through
 - Installation:** Float, Glue-down, Nail-down
- This product may be floated over radiant heat.*

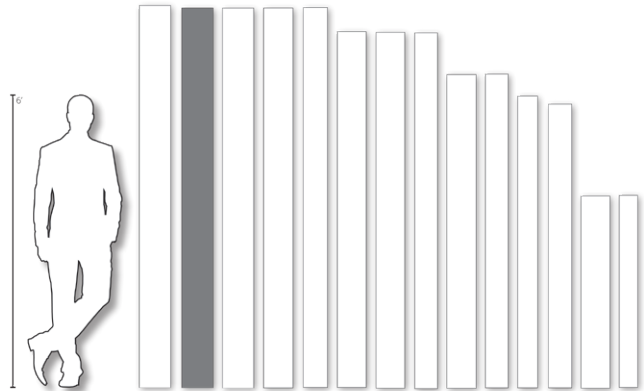

Length	Width	Thickness	Boards/Ctn	Area	Weight	Ctn/Pallet	Pallets/Cont.
95 3/8"	7 7/8"	5/8"	6	31.324ft ²	54lbs	50	16



3-Layer Construction:
 Surface layer consists of sawn strips. Solid pine fingers. Bottom layer of poplar veneer.





HARMONY COLLECTION

OAK LIMESTONE

153NOBEKOWKW 0

- Design:** 3-Strip
- Features:** Brushed European Oak, Stained, Square Edge
- Surface Treatment:** Matte Finish (UV-Cured Acrylic)
- Wear Layer:** Approx. 3.5mm (1/8")
- Grading:** Lively
- Joint:** Woodloc® 5S
- Guarantee:** Lifetime Structural
25 Year Wear Through
- Installation:** Float, Glue-down, Nail-down

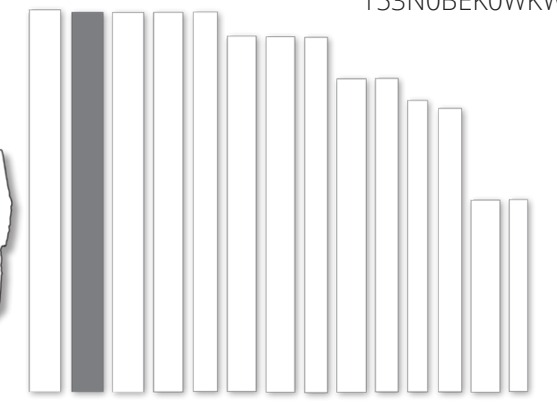

This product may be floated over radiant heat.

Length	Width	Thickness	Boards/Ctn	Area	Weight	Ctn/Pallet	Pallets/Cont.
95 3/8"	7 7/8"	5/8"	6	31.324ft ²	54lbs	50	16



3-Layer Construction:
 Surface layer consists of sawn strips. Solid pine fingers. Bottom layer of poplar veneer.





SAND COLLECTION

OAK PORTOFINO

152N38EK0VKW 0

- Design:** 2-Strip
 - Features:** European Oak, Stained, Square Edge, Smooth
 - Surface Treatment:** Matte Finish (UV-Cured Acrylic)
 - Wear Layer:** Approx. 3.5mm (1/8")
 - Grading:** Variation
 - Joint:** Woodloc® 5S
 - Guarantee:** Lifetime Structural
25 Year Wear Through
 - Installation:** Float, Glue-down, Nail-down
- This product may be floated over radiant heat.*



Length	Width	Thickness	Boards/Ctn	Area	Weight	Ctn/Pallet	Pallets/Cont.
95 3/8"	7 7/8"	5/8"	6	31.324ft²	54lbs	50	16



3-Layer Construction:

Surface layer consists of sawn strips.

Solid pine fingers.

Bottom layer of poplar veneer.





EUROPEAN
RENAISSANCE
COLLECTION



PALAZZO FUMO

EUROPEAN RENAISSANCE COLLECTION

For more than 160 years, Kährs has been working with wood. This history inspired the European Renaissance Collection, a collection of classic floors based on the magnificent floor styles of bygone periods. Something really special and totally unique.





EUROPEAN RENAISSANCE COLLECTION

PALAZZO FUMO

15313REK15KW 0

- Design:** Dutch Pattern
 - Features:** Lightly Smoked Oak, Smooth, Square Edge
 - Surface Treatment:** Matte (UV-Cured Acrylic)
 - Wear Layer:** Approx. 3.5mm (1/8")
 - Grading:** Lively
 - Joint:** Woodloc® 5S
 - Guarantee:** Lifetime Structural
25 Year Wear Through
 - Installation:** Float, Glue-down, Nail-down
- This product may be floated over radiant heat.*

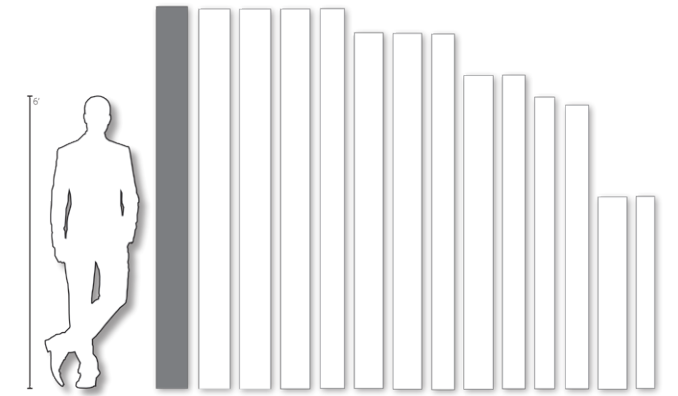

Length	Width	Thickness	Boards/Ctn	Area	Weight	Ctn/Pallet	Pallets/Cont.
95 1/2"	7 7/8"	5/8"	6	31.12ft ²	51lbs	50	16



3-Layer Construction:

Surface layer consists of sawn strips.

Solid pine fingers.

Bottom layer of poplar veneer.





EUROPEAN RENAISSANCE COLLECTION

PALAZZO ROVERE

153138EK50KW 0

- Design:** Dutch Pattern
 - Features:** Smooth Oak, Square Edge
 - Surface Treatment:** Silk Matte Finish (UV-Cured Acrylic)
 - Wear Layer:** Approx. 3.5mm (1/8")
 - Grading:** Variation
 - Joint:** Woodloc® 5S
 - Guarantee:** Lifetime Structural
25 Year Wear Through
 - Installation:** Float, Glue-down, Nail-down
- This product may be floated over radiant heat.*

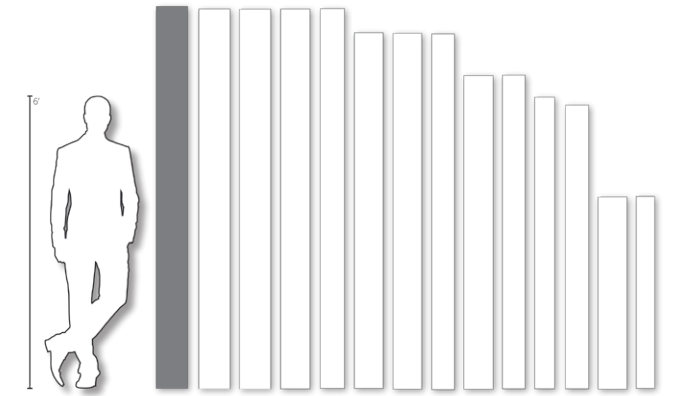

Length	Width	Thickness	Boards/Ctn	Area	Weight	Ctn/Pallet	Pallets/Cont.
95 3/8"	7 7/8"	5/8"	6	31.109ft²	54lbs	50	16



3-Layer Construction:

Surface layer consists of sawn strips.

Solid pine fingers.

Bottom layer of poplar veneer.





EUROPEAN RENAISSANCE COLLECTION

PALAZZO BIANCO

15313BEKWKW 0

- Design:** Dutch Pattern
- Features:** Brushed Oak, White Stain, Square Edge
- Surface Treatment:** Matte Finish (UV-Cured Acrylic)
- Wear Layer:** Approx. 3.5mm (1/8")
- Grading:** Variation
- Joint:** Woodloc® 5S
- Guarantee:** Lifetime Structural
25 Year Wear Through
- Installation:** Float, Glue-down, Nail-down

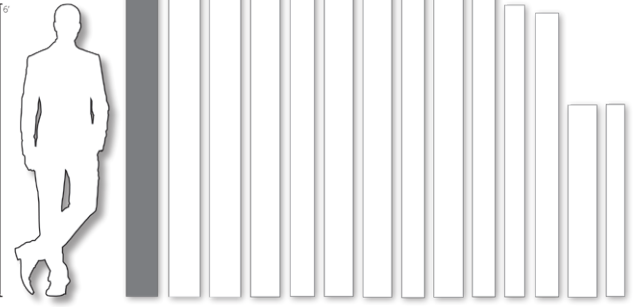

This product may be floated over radiant heat.

Length	Width	Thickness	Boards/Ctn	Area	Weight	Ctn/Pallet	Pallets/Cont.
95 3/8"	7 7/8"	5/8"	6	31.109ft ²	54lbs	50	16



3-Layer Construction:
 Surface layer consists of sawn strips. Solid pine fingers. Bottom layer of poplar veneer.





AMERICAN, EUROPEAN,
SCANDINAVIAN, &
WORLD NATURALS
COLLECTIONS



ASH GOTLAND

AMERICAN, EUROPEAN, SCANDINAVIAN & WORLD NATURALS COLLECTIONS

Vigorous, opulent species such as American Walnut, American Cherry, Canadian Maple, Scandinavian Ash, Nordic Beech, European Oak, and Brazilian Cherry - as varied as the continents - these collections cover many interior styles.





AMERICAN NATURALS COLLECTION

HARD MAPLE TORONTO

153N15AP50KW 0

- Design:** 3-Strip
- Features:** Smooth Canadian Maple, Square Edge
- Surface Treatment:** Silk Matte Finish (UV-Cured Acrylic)
- Wear Layer:** Approx. 3.5mm (1/8")
- Grading:** Calm
- Joint:** Woodloc® 5S
- Guarantee:** Lifetime Structural
25 Year Wear Through
- Installation:** Float, Glue-down, Nail-down

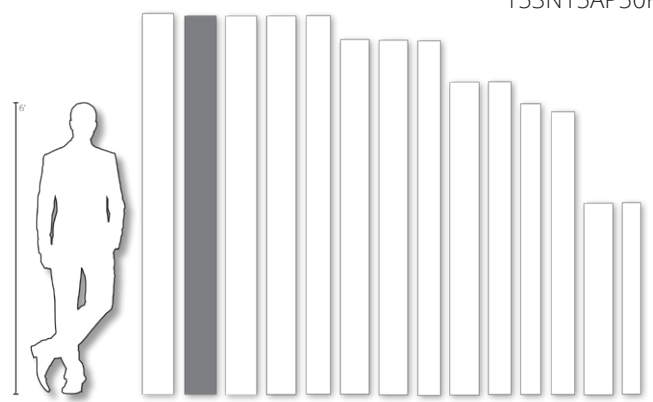

Length	Width	Thickness	Boards/Ctn	Area	Weight	Ctn/Pallet	Pallets/Cont.
95 3/8"	7 7/8"	5/8"	6	31.324ft²	54lbs	50	16



3-Layer Construction:
 Surface layer consists of sawn strips. Solid pine fingers. Bottom layer of poplar veneer.





AMERICAN NATURALS COLLECTION

CHERRY SAVANNAH

153N15CH50KW 0

- Design:** 3-Strip
 - Features:** Smooth American Cherry, Square Edge
 - Surface Treatment:** Silk Matte Finish (UV-Cured Acrylic)
 - Wear Layer:** Approx. 3.5mm (1/8")
 - Grading:** Calm
 - Joint:** Woodloc® 5S
 - Guarantee:** Lifetime Structural
25 Year Wear Through
 - Installation:** Float, Glue-down, Nail-down
- This product may be floated over radiant heat.*

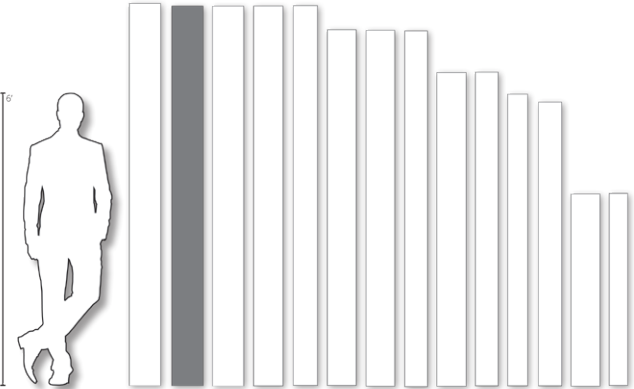

Length	Width	Thickness	Boards/Ctn	Area	Weight	Ctn/Pallet	Pallets/Cont.
95 3/8"	7 7/8"	5/8"	6	31.324ft²	54lbs	50	16



3-Layer Construction:
 Surface layer consists of sawn strips. Solid pine fingers. Bottom layer of poplar veneer.





AMERICAN NATURALS COLLECTION

WALNUT MONTREAL

153N15VA50KW 0

- Design:** 3-Strip
- Features:** Smooth American Walnut, Square Edge
- Surface Treatment:** Silk Matte Finish (UV-Cured Acrylic)
- Wear Layer:** Approx. 3.5mm (1/8")
- Grading:** Calm
- Joint:** Woodloc® 5S
- Guarantee:** Lifetime Structural
25 Year Wear Through
- Installation:** Float, Glue-down, Nail-down

This product may be floated over radiant heat.

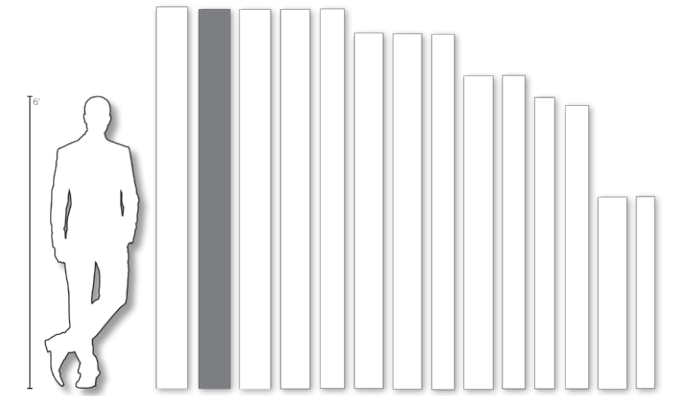

Length	Width	Thickness	Boards/Ctn	Area	Weight	Ctn/Pallet	Pallets/Cont.
95 3/8"	7 7/8"	5/8"	6	31.324ft ²	54lbs	50	16



3-Layer Construction:

Surface layer consists of sawn strips.

Solid pine fingers.

Bottom layer of poplar veneer.





EUROPEAN NATURALS COLLECTION

OAK SIENA

153N38EK50KW 0

- Design:** 3-Strip
 - Features:** Smooth White Oak, Square Edge
 - Surface Treatment:** Silk Matte Finish (UV-Cured Acrylic)
 - Wear Layer:** Approx. 3.5mm (1/8")
 - Grading:** Variation
 - Joint:** Woodloc® 5S
 - Guarantee:** Lifetime Structural
25 Year Wear Through
 - Installation:** Float, Glue-down, Nail-down
- This product may be floated over radiant heat.*

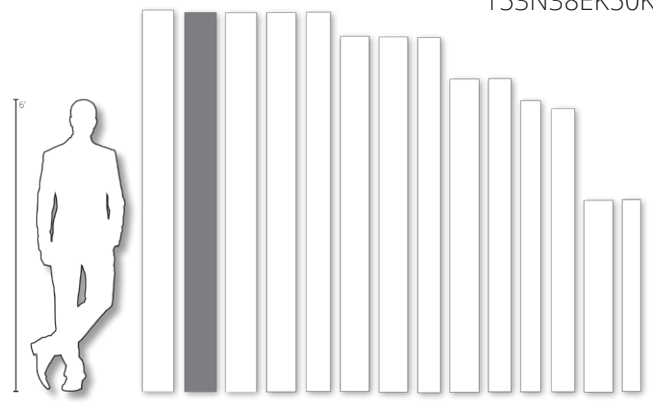

Length	Width	Thickness	Boards/Ctn	Area	Weight	Ctn/Pallet	Pallets/Cont.
95 3/8"	7 7/8"	5/8"	6	31.324ft²	54lbs	50	16



3-Layer Construction:
 Surface layer consists of sawn strips. Solid pine fingers. Bottom layer of poplar veneer.





EUROPEAN NATURALS COLLECTION

OAK VERONA

152N38EK09KW 0

- Design:** 2-Strip
 - Features:** Smooth White Oak, Square Edge
 - Surface Treatment:** Matte Finish (UV-Cured Acrylic)
 - Wear Layer:** Approx. 3.5mm (1/8")
 - Grading:** Variation
 - Joint:** Woodloc® 5S
 - Guarantee:** Lifetime Structural
25 Year Wear Through
 - Installation:** Float, Glue-down, Nail-down
- This product may be floated over radiant heat.*

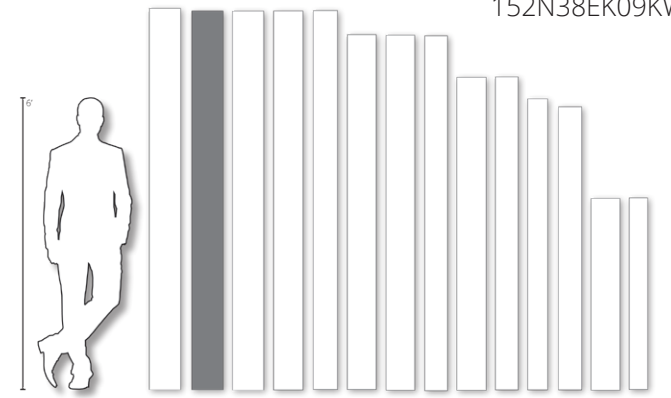

Length	Width	Thickness	Boards/Ctn	Area	Weight	Ctn/Pallet	Pallets/Cont.
95 3/8"	7 7/8"	5/8"	6	31.324ft ²	54lbs	50	16



3-Layer Construction:

Surface layer consists of sawn strips. Solid pine fingers.

Bottom layer of poplar veneer.





SCANDINAVIAN NATURALS COLLECTION

ASH GOTLAND

151L87AK50KW240

- Design:** Plank
 - Features:** Smooth Scandinavian Ash, Square Edge
 - Surface Treatment:** Silk Matte Finish (UV-Cured Acrylic)
 - Wear Layer:** Approx. 3.5mm (1/8")
 - Grading:** Lively
 - Joint:** Woodloc® 5S
 - Guarantee:** Lifetime Structural
25 Year Wear Through
 - Installation:** Float, Glue-down, Nail-down
- This product may be floated over radiant heat.*

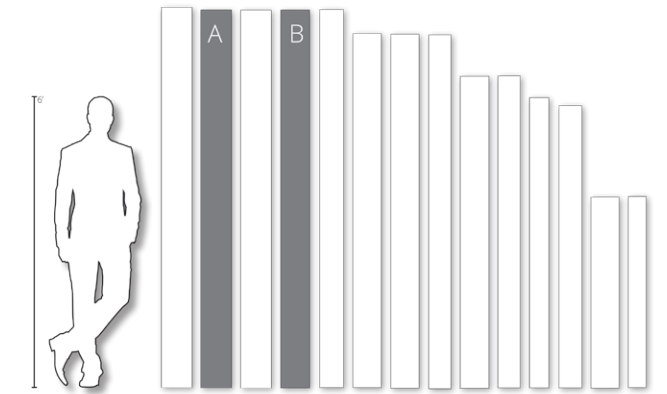

	Length	Width	Thickness	Boards/Ctn	Area	Weight	Ctn/Pallet	Pallets/Cont.
Pattern A	95 1/4"	7 3/8"	5/8"	6	29.279ft ²	49lbs	50	16



3-Layer Construction:

Surface layer: sawn plank.

Solid pine fingers.

Bottom layer of poplar veneer.





SCANDINAVIAN NATURALS COLLECTION

BEECH VIBORG

153N18BK50KW 0

- Design:** 3-Strip
- Features:** Smooth Scandinavian Beech, Square Edge
- Surface Treatment:** Silk Matte Finish (UV-Cured Acrylic)
- Wear Layer:** Approx. 3.5mm (1/8")
- Grading:** Variation
- Joint:** Woodloc® 5S
- Guarantee:** Lifetime Structural
25 Year Wear Through
- Installation:** Float, Glue-down, Nail-down

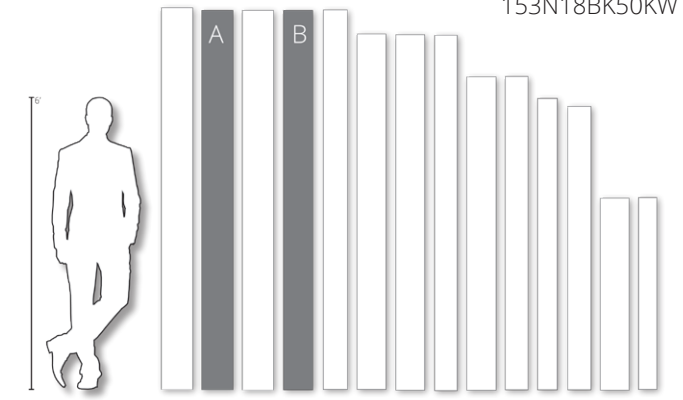

	Length	Width	Thickness	Boards/Ctn	Area	Weight	Ctn/Pallet	Pallets/Cont.
Pattern B	95 3/8"	7 7/8"	5/8"	6	31.324ft²	54lbs	50	16



3-Layer Construction:

Surface layer consists of sawn strips.

Solid pine fingers.

Bottom layer of poplar veneer.





WORLD COLLECTION

BRAZILIAN CHERRY LA PAZ

153N15JO50KW 0

- Design:** 3-Strip
 - Features:** Smooth Brazilian Cherry, Square Edge
 - Surface Treatment:** Silk Matte Finish (UV-Cured Acrylic)
 - Wear Layer:** Approx. 3.5mm (1/8")
 - Grading:** Calm
 - Joint:** Woodloc® 5S
 - Guarantee:** Lifetime Structural
25 Year Wear Through
 - Installation:** Float, Glue-down, Nail-down
- This product may be floated over radiant heat.*

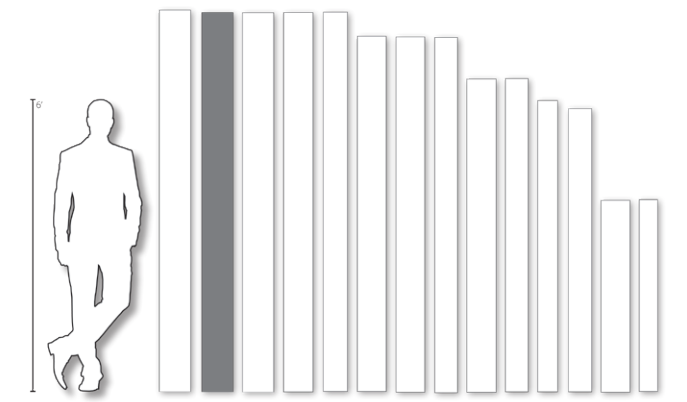

Length	Width	Thickness	Boards/Ctn	Area	Weight	Ctn/Pallet	Pallets/Cont.
95 3/8"	7 7/8"	5/8"	6	31.324ft ²	54lbs	50	16



3-Layer Construction:
 Surface layer consists of sawn strips. Solid pine fingers. Bottom layer of poplar veneer.





SMÅLAND COLLECTION

OAK TVETA



OAK VISTA

SMÅLAND COLLECTION

The historic Småland region of Sweden - whose name means "small lands" - is known for beautiful dense forests covering the terrain. As a tribute to Kährs' homeland, the floors in this collection are named after the historic "small lands" in the Småland region. This collection features specially selected Oak planks with extreme character, individually treated based on its unique composition of knots, graining, and cracks. The result is a lively and rich floor with a natural lustre and feeling.





SMÅLAND COLLECTION

OAK VISTA

- Design:** Plank
- Features:** Rustic Oak, Stained, Brushed, Handscraped, Beveled Edges
- Surface Treatment:** Oil
- Wear Layer:** Approx. 3.5mm (1/8")
- Grading:** Dynamic
- Joint:** Woodloc® 5S
- Guarantee:** Lifetime Structural
- Installation:** Float, Glue-down, Nail-down

This product may be floated over radiant heat.

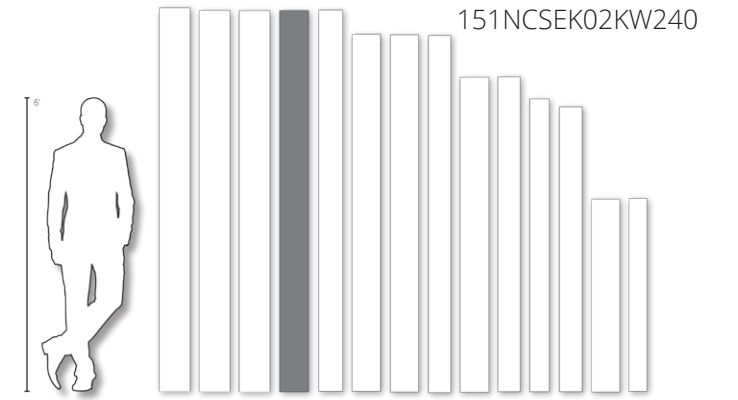

Length	Width	Thickness	Boards/Ctn	Area	Weight	Ctn/Pallet	Pallets/Cont.
95 1/4"	7 3/8"	5/8"	6	29.279ft²	49lbs	50	16



This product must be oiled immediately after installation and prior to use.





SMÅLAND COLLECTION

OAK ASPELAND

151NDSEK01KW240

- Design:** Plank
 - Features:** Rustic Oak, Stained, Brushed, Saw Marks, Handscraped, Beveled Edges
 - Surface Treatment:** Oil
 - Wear Layer:** Approx. 3.5mm (1/8")
 - Grading:** Expressive
 - Joint:** Woodloc® 5S
 - Guarantee:** Lifetime Structural
 - Installation:** Float, Glue-down, Nail-down
- This product may be floated over radiant heat.*

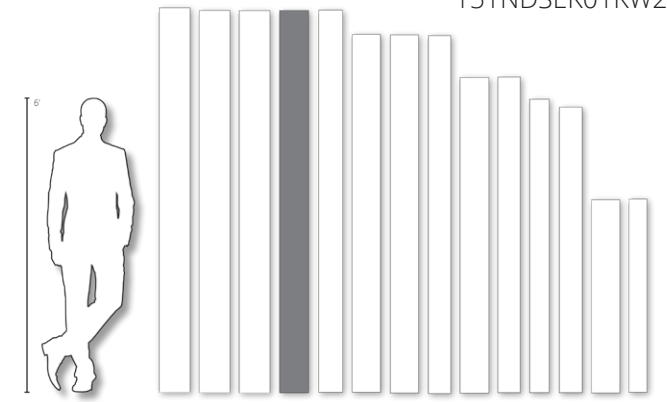

Length	Width	Thickness	Boards/Ctn	Area	Weight	Ctn/Pallet	Pallets/Cont.
95 1/4"	7 3/8"	5/8"	6	29.279ft ²	49lbs	50	16

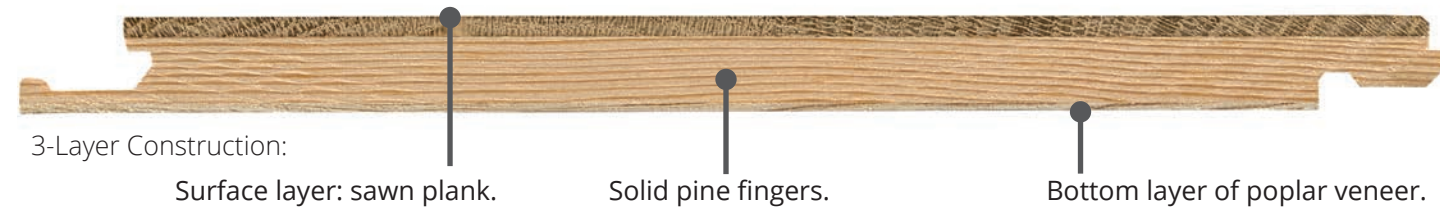

This product must be oiled immediately after installation and prior to use.





SMÅLAND COLLECTION

OAK MÖRE

151NCSEK03KW240

- Design:** Plank
- Features:** Rustic Oak, Stained, Brushed, Handscraped, Beveled Edges
- Surface Treatment:** Oil
- Wear Layer:** Approx. 3.5mm (1/8")
- Grading:** Dynamic
- Joint:** Woodloc® 5S
- Guarantee:** Lifetime Structural
- Installation:** Float, Glue-down, Nail-down

This product may be floated over radiant heat.

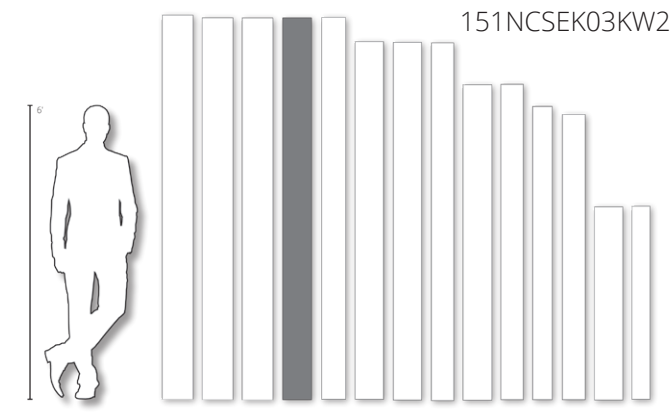

Length	Width	Thickness	Boards/Ctn	Area	Weight	Ctn/Pallet	Pallets/Cont.
95 1/4"	7 3/8"	5/8"	6	29.279ft²	49lbs	50	16



This product must be oiled immediately after installation and prior to use.





SMÅLAND COLLECTION

OAK VEDBO

151NCSEK01KW240

- Design:** Plank
 - Features:** Rustic Oak, Brushed, Handscraped, Beveled Edges
 - Surface Treatment:** Oil
 - Wear Layer:** Approx. 3.5mm (1/8")
 - Grading:** Dynamic
 - Joint:** Woodloc® 5S
 - Guarantee:** Lifetime Structural
 - Installation:** Float, Glue-down, Nail-down
- This product may be floated over radiant heat.*

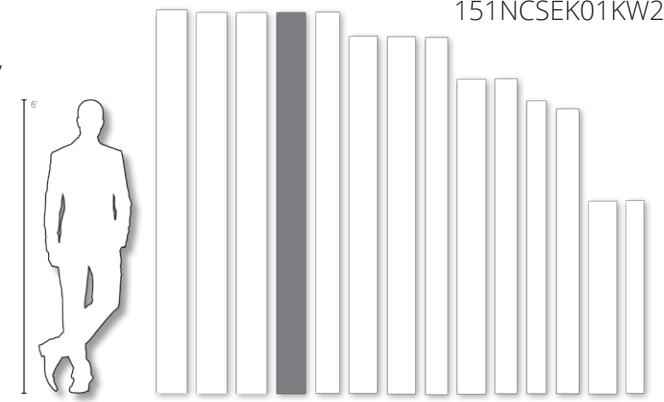

Length	Width	Thickness	Boards/Ctn	Area	Weight	Ctn/Pallet	Pallets/Cont.
95 1/4"	7 3/8"	5/8"	6	29.279ft ²	49lbs	50	16



3-Layer Construction:

Surface layer: sawn plank.

Solid pine fingers.

Bottom layer of poplar veneer.

This product must be oiled immediately after installation and prior to use.





SMÅLAND COLLECTION

OAK FINNVEDEN

151NDSEK03KW240

- Design:** Plank
 - Features:** Rustic Oak, Stained, Brushed, Saw Marks, Handscraped, Beveled Edges
 - Surface Treatment:** Oil
 - Wear Layer:** Approx. 3.5mm (1/8")
 - Grading:** Expressive
 - Joint:** Woodloc® 5S
 - Guarantee:** Lifetime Structural
 - Installation:** Float, Glue-down, Nail-down
- This product may be floated over radiant heat.*

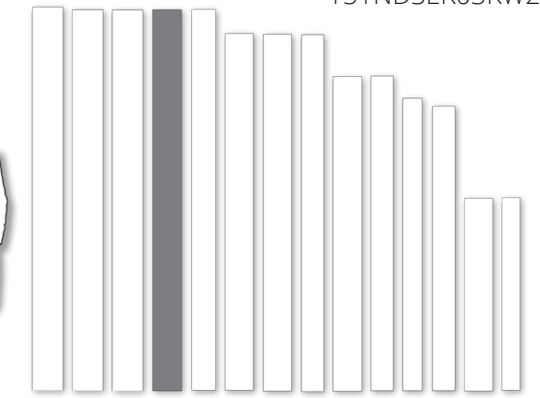

Length	Width	Thickness	Boards/Ctn	Area	Weight	Ctn/Pallet	Pallets/Cont.
95 1/4"	7 3/8"	5/8"	6	29.279ft ²	49lbs	50	16



3-Layer Construction:

Surface layer: sawn plank.

Solid pine fingers.

Bottom layer of poplar veneer.

This product must be oiled immediately after installation and prior to use.





SMÅLAND COLLECTION

OAK YDRE

151NCSEK04KW240

- Design:** Plank
- Features:** Rustic Oak, Stained, Brushed, Handscraped, Lightly Smoked, Beveled Edges
- Surface Treatment:** Oil
- Wear Layer:** Approx. 3.5mm (1/8")
- Grading:** Dynamic
- Joint:** Woodloc® 5S
- Guarantee:** Lifetime Structural
- Installation:** Float, Glue-down, Nail-down

This product may be floated over radiant heat.

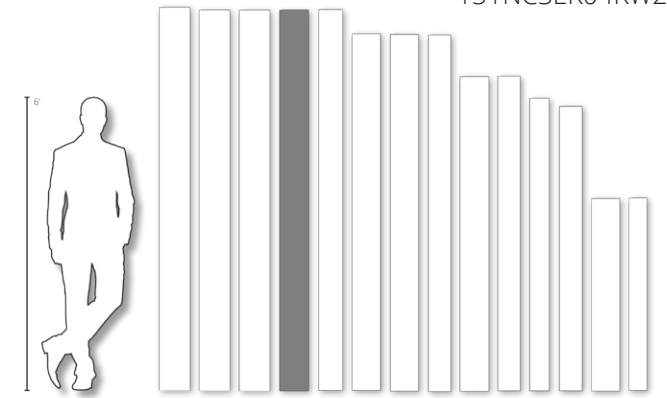

Length	Width	Thickness	Boards/Ctn	Area	Weight	Ctn/Pallet	Pallets/Cont.
95 1/4"	7 3/8"	5/8"	6	29.279ft²	49lbs	50	16



3-Layer Construction:

Surface layer: sawn plank.

Solid pine fingers.

Bottom layer of poplar veneer.

This product must be oiled immediately after installation and prior to use.





SMÅLAND COLLECTION

OAK TVETA

151NDSEK04KW240

- Design:** Plank
- Features:** Rustic Oak, Stained, Brushed, Handscraped, Lightly Smoked, Saw Marks, Beveled Edges
- Surface Treatment:** Oil
- Wear Layer:** Approx. 3.5mm (1/8")
- Grading:** Expressive
- Joint:** Woodloc® 5S
- Guarantee:** Lifetime Structural
- Installation:** Float, Glue-down, Nail-down

This product may be floated over radiant heat.



Length	Width	Thickness	Boards/Ctn	Area	Weight	Ctn/Pallet	Pallets/Cont.
95 1/4"	7 3/8"	5/8"	6	29.279ft ²	49lbs	50	16



3-Layer Construction:

Surface layer: sawn plank.

Solid pine fingers.

Bottom layer of poplar veneer.

This product must be oiled immediately after installation and prior to use.





SMÅLAND COLLECTION

OAK SEVEDE

151NCSEK05KW240

- Design:** Plank
- Features:** Rustic Oak, Stained, Brushed, Handscraped, Lightly Smoked, Beveled Edges
- Surface Treatment:** Oil
- Wear Layer:** Approx. 3.5mm (1/8")
- Grading:** Dynamic
- Joint:** Woodloc® 5S
- Guarantee:** Lifetime Structural
- Installation:** Float, Glue-down, Nail-down

This product may be floated over radiant heat.

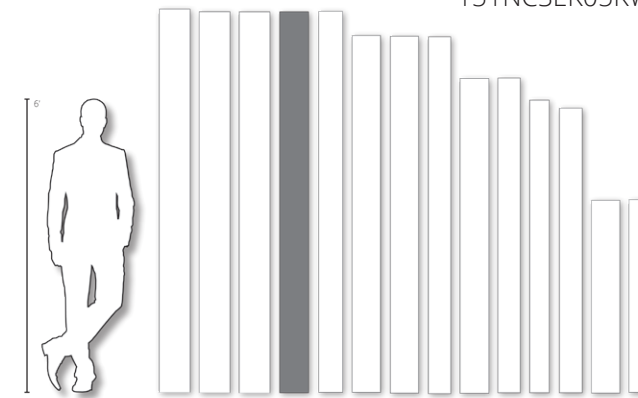

Length	Width	Thickness	Boards/Ctn	Area	Weight	Ctn/Pallet	Pallets/Cont.
95 1/4"	7 3/8"	5/8"	6	29.279ft ²	49lbs	50	16



3-Layer Construction:

Surface layer: sawn plank.

Solid pine fingers.

Bottom layer of poplar veneer.

This product must be oiled immediately after installation and prior to use.





SMÅLAND COLLECTION

OAK HANDBÖRD

151NDSEK06KW240

- Design:** Plank
- Features:** Rustic Oak, Handscraped, Stained, Brushed, Lightly Smoked, Saw Marks, Beveled Edges
- Surface Treatment:** Oil
- Wear Layer:** Approx. 3.5mm (1/8")
- Grading:** Expressive
- Joint:** Woodloc® 5S
- Guarantee:** Lifetime Structural
- Installation:** Float, Glue-down, Nail-down

This product may be floated over radiant heat.

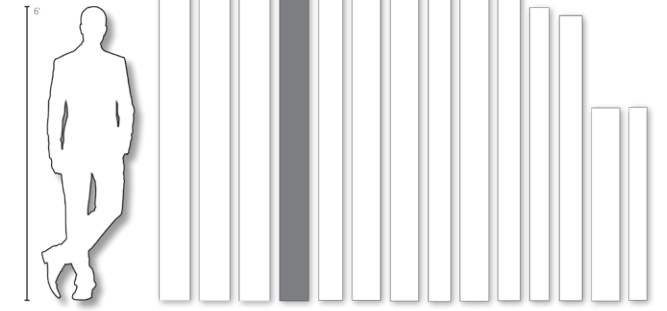

Length	Width	Thickness	Boards/Ctn	Area	Weight	Ctn/Pallet	Pallets/Cont.
95 1/4"	7 3/8"	5/8"	6	29.279ft ²	49lbs	50	16



3-Layer Construction:

Surface layer: sawn plank.

Solid pine fingers.

Bottom layer of poplar veneer.

This product must be oiled immediately after installation and prior to use.



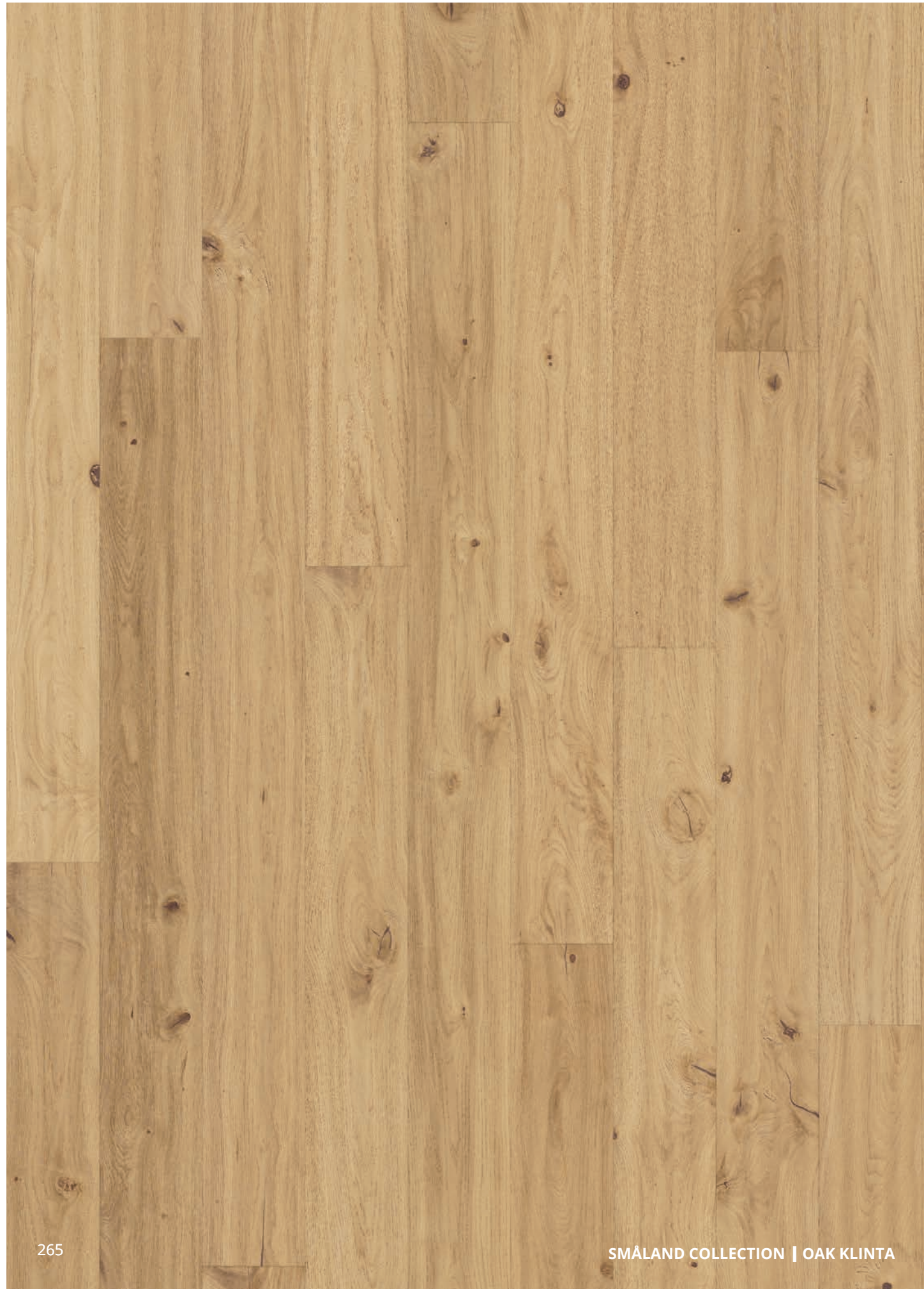

SMÅLAND COLLECTION

- Design:** Plank
- Features:** Rustic Oak, Stained, Brushed, Handscraped, Beveled Edges
- Surface Treatment:** Oil
- Wear Layer:** Approx. 3.5mm (1/8")
- Grading:** Dynamic
- Joint:** Woodloc® 5S
- Guarantee:** Lifetime Structural
- Installation:** Float, Glue-down, Nail-down

This product may be floated over radiant heat.

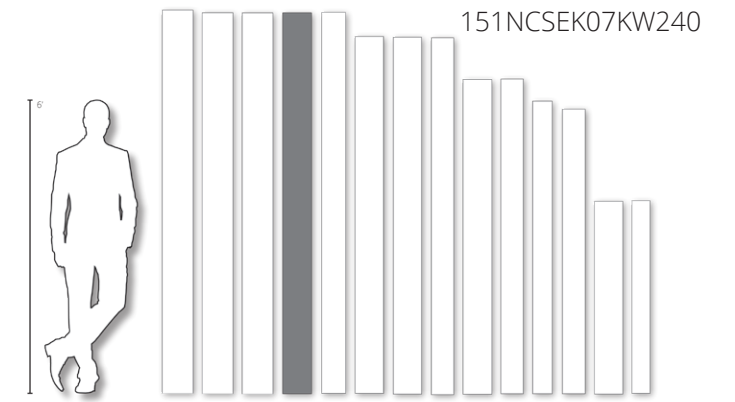

OAK KLINTA

151NCSEK07KW240

Length	Width	Thickness	Boards/Ctn	Area	Weight	Ctn/Pallet	Pallets/Cont.
95 1/4"	7 3/8"	5/8"	6	29.279ft ²	49lbs	50	16



This product must be oiled immediately after installation and prior to use.





KÄHR'S COMPLETE FLOORING SYSTEM FOR HARDWOOD FLOORS

Kährs offers a wide range of tools and materials to make installation easy and help achieve a perfect end result. The range includes a variety of underlayments, installation tools, and moldings, as well as maintenance products specially designed for our hardwood floors.

Please email info@kahrs.com for more information on ordering maintenance products and accessories.

MOLDINGS FOR ALL KÄHRS WOOD FLOORS

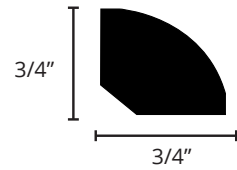

QUARTER ROUND

Conceals expansion space between the wall and Kährs hardwood flooring. Also used to transition between wood flooring and cabinetry.

Applicable Collections	Molding Dimensions	Pieces per Order	Shipment Weight
All Floors	3/4" x 3/4" x 78"	10	10 lbs

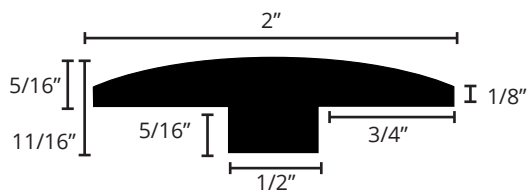

T-MOLDING

Used in doorways to blend flooring surfaces in adjoining rooms or where floors of the same thickness meet.

Applicable Collections	Molding Dimensions	Pieces per Order	Shipment Weight
All Floors	2" x 1 1/16" x 78"	5	25 lbs

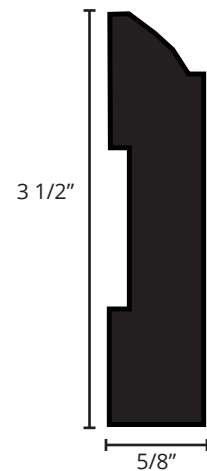

WALL BASE

Provides an elegant, traditional transition from the flooring to wall. Gives any room a more formal, finished appearance.

Applicable Collections	Molding Dimensions	Pieces per Order	Shipment Weight
All Floors	5/8" x 3 1/2" x 78"	5	25 lbs

SQUARE NOSE REDUCER

Installed against vertical surfaces such as patio doors or fireplace hearths.

Applicable Collections	Molding Dimensions	Pieces per Order	Shipment Weight
Kährs Life (7mm)	1 1/2" x 3/4" x 78"	5	10 lbs
Kährs Avanti (13mm) Kährs Original, Supreme, ID (15mm)	1 1/2" x 7/8" x 78"	5	10 lbs

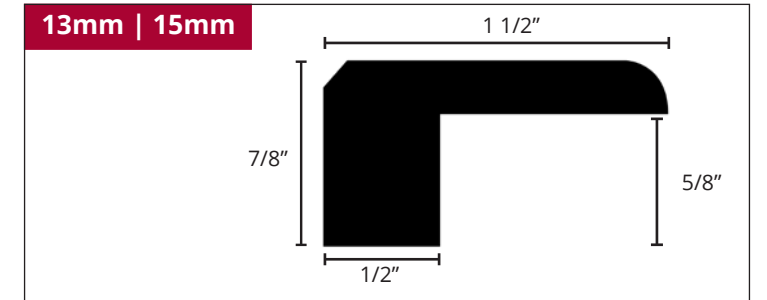
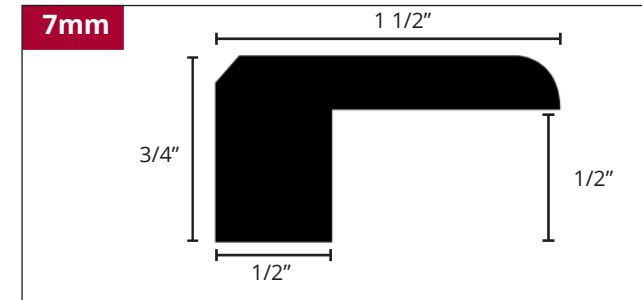

OVERLAP REDUCER

Used with floating floor applications to provide a smooth transition between floors of different heights. Overlap profile allows the installed flooring to expand and contract.

Applicable Collections	Molding Dimensions	Pieces per Order	Shipment Weight
Kährs Life (7mm)	1 1/2" x 3/8" x 78"	5	10 lbs
Kährs Avanti (13mm) Kährs Original, Supreme, ID (15mm)	2 3/8" x 3/4" x 78"	5	10 lbs

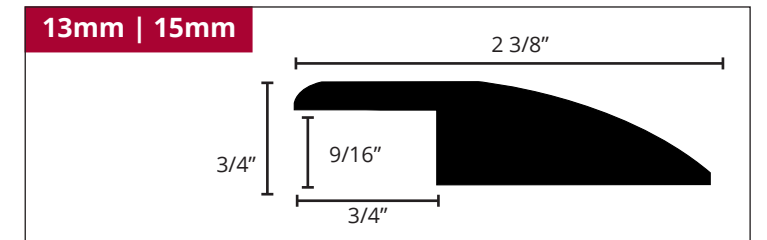
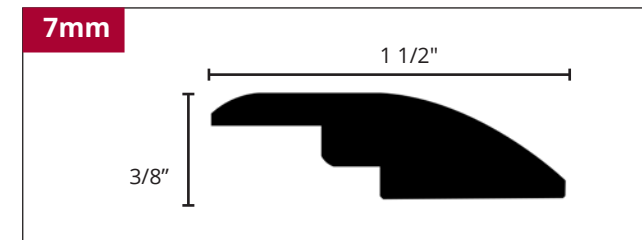

THRESHOLD

Ideal for doorways or to transition between floors of different heights. Used with wood, tile or carpet.

Applicable Collections	Molding Dimensions	Pieces per Order	Shipment Weight
Kährs Life (7mm)	2" x 3/4" x 78"	10	10 lbs
Kährs Avanti (13mm) Kährs Original, Supreme, ID (15mm)	2" x 7/8" x 78"	5	10 lbs

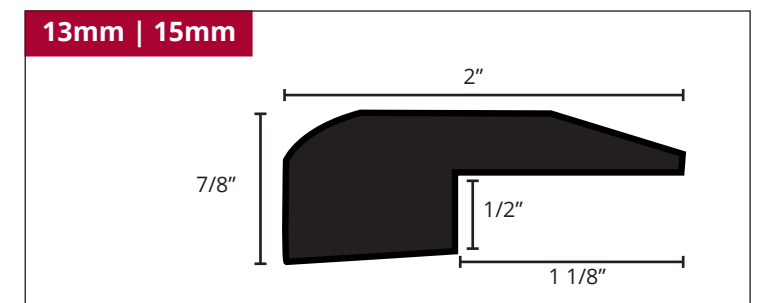
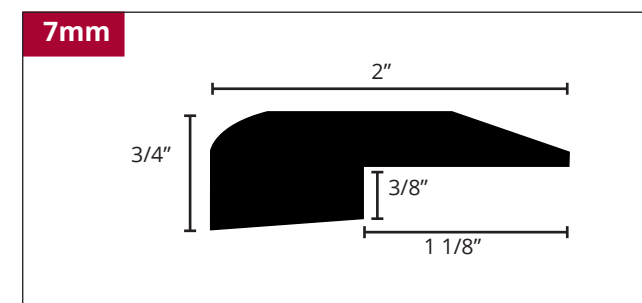

OVERLAP STAIR NOSINGS

Applicable Collections	Molding Dimensions	Pieces per Order	Shipment Weight
Kährs Life (7mm)	2" x 13/16" x 78"	5	20 lbs
Kährs Avanti (13mm) Kährs Original, Supreme, ID (15mm)	3" x 13/16" x 78"	5	20 lbs

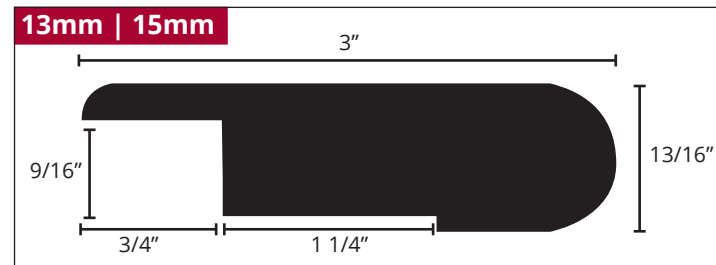
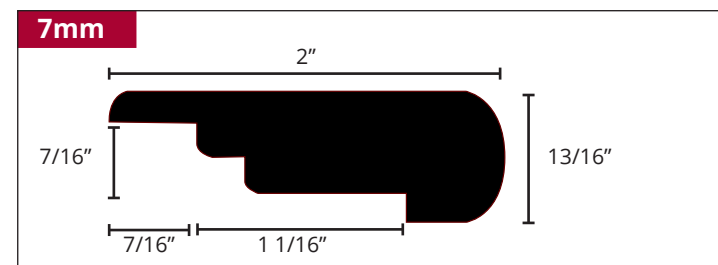

WOODLOC® FLUSH STAIR NOSINGS

Applicable Collections	Molding Dimensions	Pieces per Order	Shipment Weight
Kährs Avanti (13mm)	2 7/8" x 13/16" x 78"	5	20 lbs
Kährs Original, Supreme (15mm)	3 3/8" x 13/16" x 78"	5	20 lbs

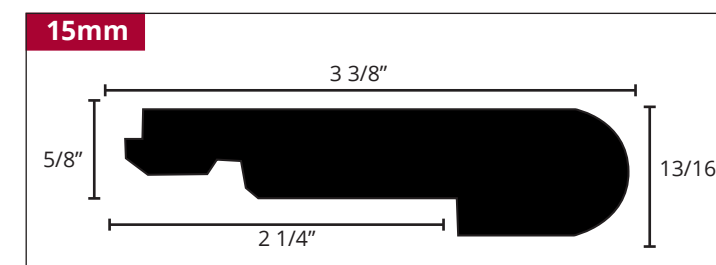
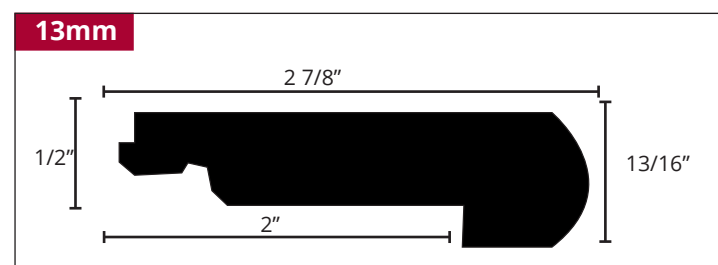

FLUSH STAIR NOSINGS, WOODLOC®

Applicable Collections	Molding Dimensions	Pieces per Order	Shipment Weight
Kährs Life (7mm)	2" x 13/16" x 78"	5	20 lbs

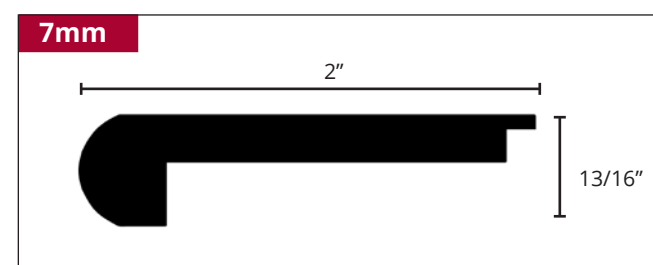

FLUSH STAIR NOSINGS, TONGUE & GROOVE

Applicable Collections	Molding Dimensions	Pieces per Order	Shipment Weight
Kährs ID (15mm)	3" x 13/16" x 78"	5	20 lbs

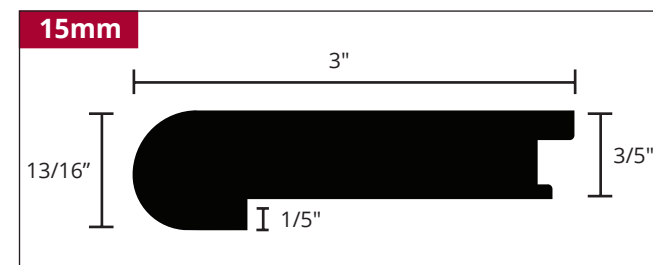

Transition Profile

T-Molding 7mm, 10mm
 T-Molding 13mm, 15mm
 Square Nose 7mm, 10mm
 Square Nose 13mm, 15mm
 Threshold 7mm, 10mm
 Threshold 13mm, 15mm
 Overlap Reducer 7mm
 Overlap Reducer 10mm
 Overlap Reducer 13mm, 15mm

Setback Distance

1 1/2"
 1 1/2"
 7/8"
 1 1/4"
 3/8"
 1 3/8"
 1 3/8"
 2 1/8"
 2 1/4"



Kährs Floor Cleaner

710804

750 ml bottle Kährs Floor Cleaner
 Can be used on both Kährs Hardwood and Kährs Luxury Tile Products.



Kährs Satin Oil

710553

No mixing required!

TO BE USED IMMEDIATELY AFTER INSTALLATION AND PRIOR TO USE OF THE FLOOR

Apply a thin layer of Kährs Satin Oil on the surface and spread it evenly with a Kährs Micro Fiber Mop or a dry cloth along the grain of the board. Polish again with a new Micro Fiber Mop head after 10-15 minutes so that no residue is left behind. 1 l of Kährs Satin Oil per 2,000ft².

1 liter
 2 lbs

HARDWOOD FLOORING MAINTENANCE PRODUCTS

Kährs Floor Care Kit

710526

Maintenance kit containing: dry mop, bottle of Kährs Cleaner, and Kährs Floor Care Guide.
1 kit per carton
5 lbs



Microfiber Replacement Pad

710512

Replacement pad for dry mop.
2 lbs



[CLICK TO RETURN TO TABLE OF CONTENTS](#)

HARDWOOD FLOORING UNDERLAYMENTS

Kährs Combo System



Roll Coverage	100 ft ²	630 ft ²
Roll Length	30'	189'
Roll Width	40"	40"
Thickness	1/8"	1/8"
Roll Weight	3 lbs, 3 oz	21 lbs
Roll Diameter	7 1/8"	16 1/2"
Item Number	710100	710107
Sound Rating	IIC = 68	

- Helps level the subfloor
- Provides moisture barrier/ventilation
- Compressibility-holds its shape under heavy loads
- Meets requirements for Kährs Lifetime Guarantee
- Mold reducing, inert and non-reactive construction
- Lightweight with Integrated overlap seal
- Ideal for radiant heating

Kährs Eco+



Roll Coverage	100 ft ²	450 ft ² *
Roll Length	33' 4"	75'
Roll Width	3'	6'
Thickness	1/8"	1/8"
Roll Weight	16 lbs	74 lbs
Roll Diameter	7"	11"
Item Number	711100	711450*
Sound Rating	IIC = 70	

- Excellent acoustical performance
- Meets requirements for Kährs Lifetime Guarantee
- Lightweight with Integrated overlap seal
- 100% high density memory foam
- Premium polyurethane construction
- Guaranteed over radiant heat
- UL GreenGuard GOLD certified
- Breathable moisture barrier;
Up to 10lbs moisture emission
- Ultra-fresh antimicrobial protection
- Free from formaldehyde, latex, PBDE's
- Made in part with natural resources
- 100% recyclable
- Eligible for LEED credits

*Special Order

Kährs QuietStride 2.0



Roll Coverage	300 ft ²
Roll Length	75'
Roll Width	48"
Thickness	1/8"
Roll Weight	120 lbs
Roll Diameter	9"
Item Number	710112
Sound Rating	IIC = 57

- Glue down, floating installations
- Enhances underfoot comfort
- Conceals minor subfloor irregularities
- Always lays flat and will not slip during installation
- Approved for 'double-stick' installations
- 92% recycled tire content and 100% recyclable
- FloorScore certified & Contributes to LEED credits
- Guaranteed over radiant heat
- Resists mold, mildew, and fungus growth



AWARE
COLLECTION



KAPPADOKIEN

AWARE COLLECTION **PVC-FREE** HYBRID FLOORING

The Aware Collection is a bio-based, natural floor designed to withstand family-life and the wear and tear of commercial applications, while offering the style, beauty, and feel of a wood floor. With colors inspired by national parks around the world, the collection features a range of 9 different, rustic wood design planks.





AWARE COLLECTION

KAPPADOKIEN

LTAWAW1112

- Design:** Wood Design
- Features:** PVC-free, bio-based, four-sided microbevel, wood grain embossing
- Surface Treatment:** Ultra Matte Finish
- Joint:** Click
- Guarantee:** 25 Year Residential
10 Year Commercial
- Installation:** Float

This product may be floated over radiant heat.

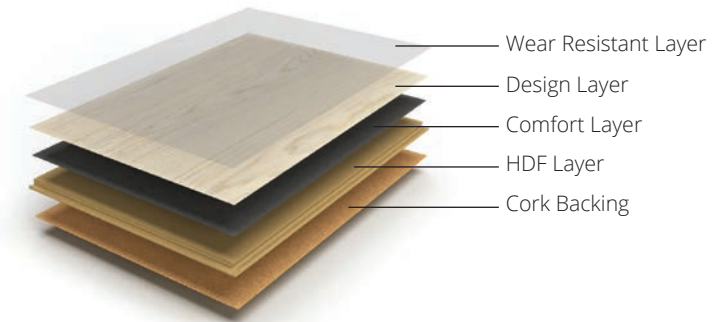

Length	Width	Thickness	Boards/Ctn	Area	Weight	Ctn/Pallet	Pallets/Cont.
71 1/2"	7 7/8"	3/8"	6	23.4ft ²	34.9lbs	48	26





AWARE COLLECTION

BWINDI

LTAWAW1111

- Design:** Wood Design
- Features:** PVC-free, bio-based, four-sided microbevel, wood grain embossing
- Surface Treatment:** Ultra Matte Finish
- Joint:** Click
- Guarantee:** 25 Year Residential
10 Year Commercial
- Installation:** Float

This product may be floated over radiant heat.

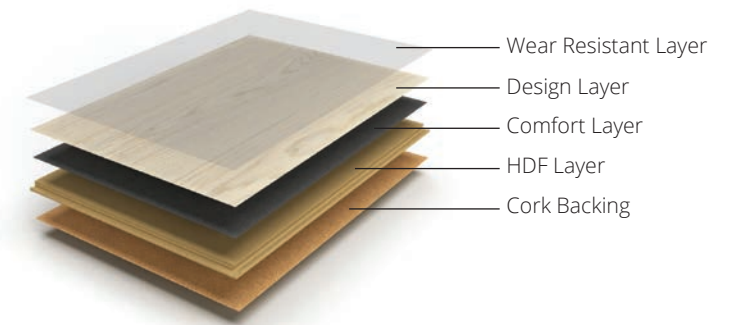

Length	Width	Thickness	Boards/Ctn	Area	Weight	Ctn/Pallet	Pallets/Cont.
71 1/2"	7 7/8"	3/8"	6	23.4ft ²	34.9lbs	48	26





AWARE COLLECTION

GRAND CANYON

LTAWAW1113

- Design:** Wood Design
- Features:** PVC-free, bio-based, four-sided microbevel, wood grain embossing
- Surface Treatment:** Ultra Matte Finish
- Joint:** Click
- Guarantee:** 25 Year Residential
10 Year Commercial
- Installation:** Float

This product may be floated over radiant heat.

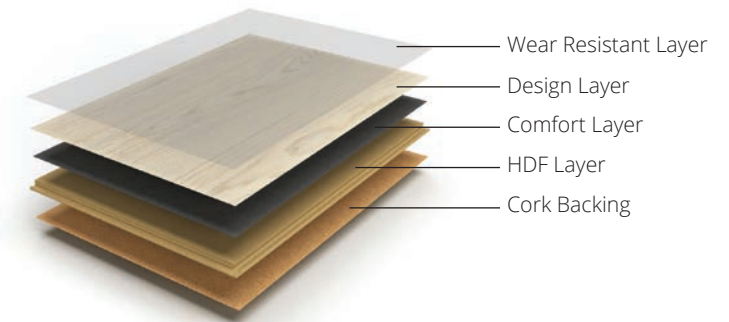

Length	Width	Thickness	Boards/Ctn	Area	Weight	Ctn/Pallet	Pallets/Cont.
71 1/2"	7 7/8"	3/8"	6	23.4ft ²	34.9lbs	48	26





AWARE COLLECTION

YOSEMITE

LTAWAW1114

- Design:** Wood Design
- Features:** PVC-free, bio-based, four-sided microbevel, wood grain embossing
- Surface Treatment:** Ultra Matte Finish
- Joint:** Click
- Guarantee:** 25 Year Residential
10 Year Commercial
- Installation:** Float

This product may be floated over radiant heat.

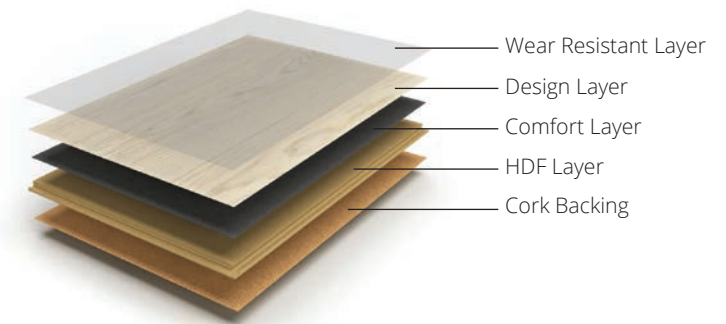

Length	Width	Thickness	Boards/Ctn	Area	Weight	Ctn/Pallet	Pallets/Cont.
71 1/2"	7 7/8"	3/8"	6	23.4ft ²	34.9lbs	48	26





AWARE COLLECTION

SERENGETI

LTAWAW1115

- Design:** Wood Design
- Features:** PVC-free, bio-based, four-sided microbevel, wood grain embossing
- Surface Treatment:** Ultra Matte Finish
- Joint:** Click
- Guarantee:** 25 Year Residential
10 Year Commercial
- Installation:** Float

This product may be floated over radiant heat.

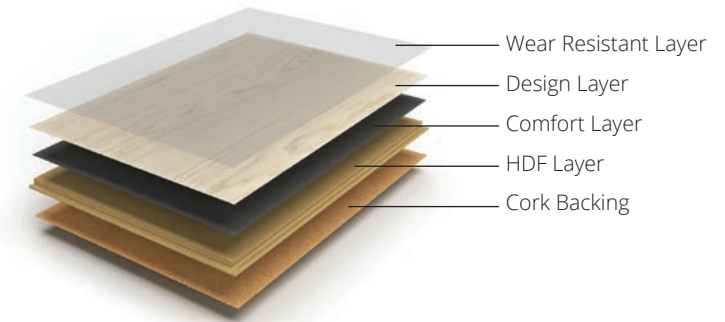

Length	Width	Thickness	Boards/Ctn	Area	Weight	Ctn/Pallet	Pallets/Cont.
71 1/2"	7 7/8"	3/8"	6	23.4ft ²	34.9lbs	48	26





AWARE COLLECTION

YELLOWSTONE

LTAWAW1117

- Design:** Wood Design
- Features:** PVC-free, bio-based, four-sided microbevel, wood grain embossing
- Surface Treatment:** Ultra Matte Finish
- Joint:** Click
- Guarantee:** 25 Year Residential
10 Year Commercial
- Installation:** Float

This product may be floated over radiant heat.

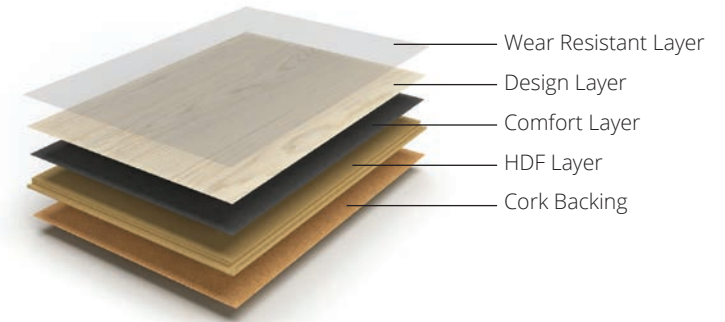

Length	Width	Thickness	Boards/Ctn	Area	Weight	Ctn/Pallet	Pallets/Cont.
71 1/2"	7 7/8"	3/8"	6	23.4ft ²	34.9lbs	48	26





AWARE COLLECTION

ROCKY

LTAWAW1119

- Design:** Wood Design
- Features:** PVC-free, bio-based, four-sided microbevel, wood grain embossing
- Surface Treatment:** Ultra Matte Finish
- Joint:** Click
- Guarantee:** 25 Year Residential
10 Year Commercial
- Installation:** Float

This product may be floated over radiant heat.

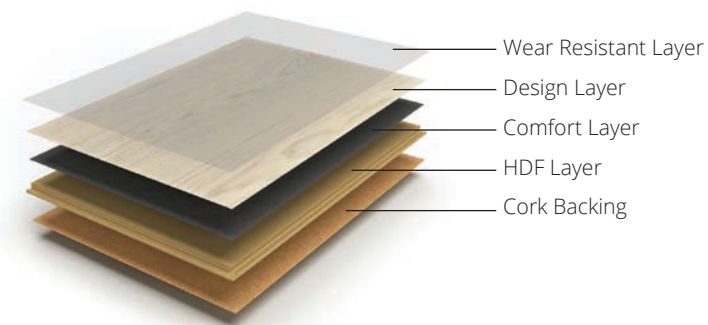

Length	Width	Thickness	Boards/Ctn	Area	Weight	Ctn/Pallet	Pallets/Cont.
71 1/2"	7 7/8"	3/8"	6	23.4ft ²	34.9lbs	48	26





AWARE COLLECTION

SMOKY

LTAWAW1118

- Design:** Wood Design
- Features:** PVC-free, bio-based, four-sided microbevel, wood grain embossing
- Surface Treatment:** Ultra Matte Finish
- Joint:** Click
- Guarantee:** 25 Year Residential
10 Year Commercial
- Installation:** Float

This product may be floated over radiant heat.

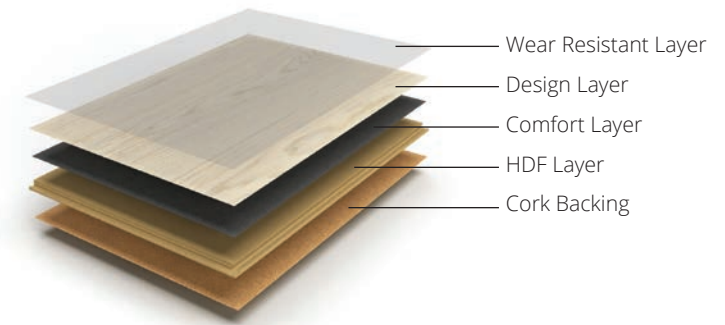

Length	Width	Thickness	Boards/Ctn	Area	Weight	Ctn/Pallet	Pallets/Cont.
71 1/2"	7 7/8"	3/8"	6	23.4ft ²	34.9lbs	48	26





AWARE COLLECTION

JASPER

LTAWAW1116

- Design:** Wood Design
- Features:** PVC-free, bio-based, four-sided microbevel, wood grain embossing
- Surface Treatment:** Ultra Matte Finish
- Joint:** Click
- Guarantee:** 25 Year Residential
10 Year Commercial
- Installation:** Float

This product may be floated over radiant heat.

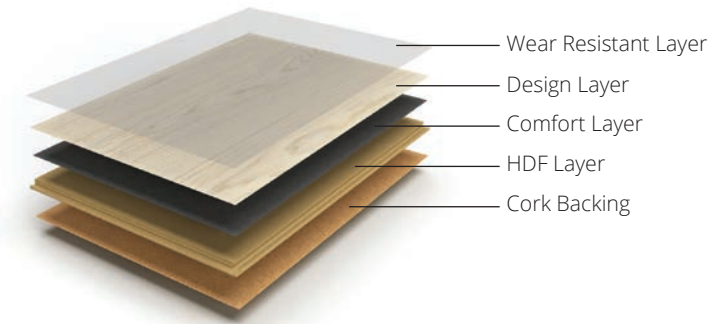

Length	Width	Thickness	Boards/Ctn	Area	Weight	Ctn/Pallet	Pallets/Cont.
71 1/2"	7 7/8"	3/8"	6	23.4ft ²	34.9lbs	48	26





CLICK 5MM
COLLECTION



KÄHRS LUXURY TILES 5MM CLICK

Kährs Luxury Tiles are designed for everyday life. These LVT floors are waterproof, phthalate-free, and durable, made for families, dogs, dirty shoes, and high heels. With a click locking system, sound-reducing backing, and ceramic coating, these Luxury Tiles are easy to install and just as easy to enjoy.



SOUND
REDUCTION



WATERPROOF
MATERIAL



FREE FROM
PHTHALATES



RIGID
CORE



5G CLICK
TECHNOLOGY



CERAMIC
COATING

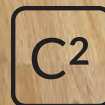

UNDERFLOOR
HEATING



- Design:** Wood Look Plank
- Surface Treatment:** Ceramic Coating
- Wear Layer:** 12 mil*
- Joint:** 5G Click
- Guarantee:** 5 Year Commercial
25 Year Residential
- Installation:** Float

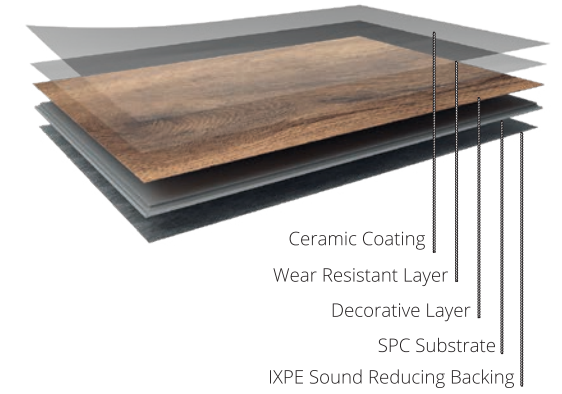

This product may be floated over radiant heat.

*Also available in 6mm format (22 mil wear layer) by special order.
Contact a Kährs rep for more information.

Length	Width	Thickness	Pcs/Ctn	SF/Ctn
47 5/8"	6 3/4"	5mm	10	22.39



- Design:** Wood Look Plank
- Surface Treatment:** Ceramic Coating
- Wear Layer:** 12 mil*
- Joint:** 5G Click
- Guarantee:** 5 Year Commercial
25 Year Residential
- Installation:** Float

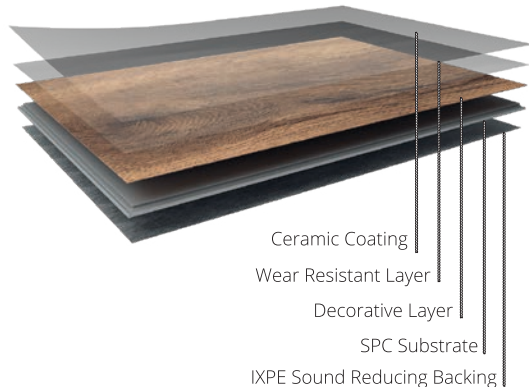

This product may be floated over radiant heat.

*Also available in 6mm format (22 mil wear layer) by special order. Contact a Kährs rep for more information.

Length	Width	Thickness	Pcs/Ctn	SF/Ctn
47 5/8"	6 3/4"	5mm	10	22.39





- Design:** Wood Look Plank
- Surface Treatment:** Ceramic Coating
- Wear Layer:** 12 mil*
- Joint:** 5G Click
- Guarantee:** 5 Year Commercial
25 Year Residential
- Installation:** Float

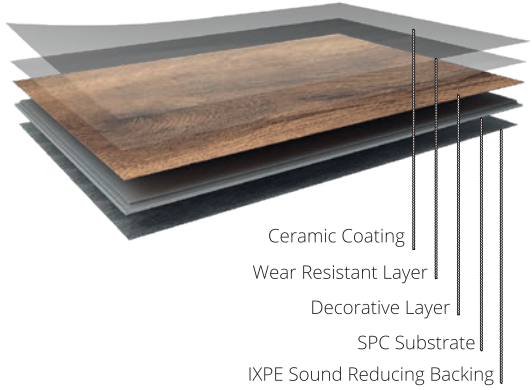

This product may be floated over radiant heat.

*Also available in 6mm format (22 mil wear layer) by special order. Contact a Kährs rep for more information.

Length	Width	Thickness	Pcs/Ctn	SF/Ctn
47 5/8"	6 3/4"	5mm	10	22.39





KÄHRS LUXURY TILES 5MM CLICK | WOOD DESIGN

YUKON CLW 172

LTCLW2102-172

- Design:** Wood Look Plank
- Surface Treatment:** Ceramic Coating
- Wear Layer:** 12 mil*
- Joint:** 5G Click
- Guarantee:** 5 Year Commercial
25 Year Residential
- Installation:** Float



Ceramic Coating
Wear Resistant Layer
Decorative Layer
SPC Substrate
IXPE Sound Reducing Backing

This product may be floated over radiant heat.

*Also available in 6mm format (22 mil wear layer) by special order. Contact a Kährs rep for more information.

Length	Width	Thickness	Pcs/Ctn	SF/Ctn
47 5/8"	6 3/4"	5mm	10	22.39



- Design:** Wood Look Plank
- Surface Treatment:** Ceramic Coating
- Wear Layer:** 12 mil*
- Joint:** 5G Click
- Guarantee:** 5 Year Commercial
25 Year Residential
- Installation:** Float

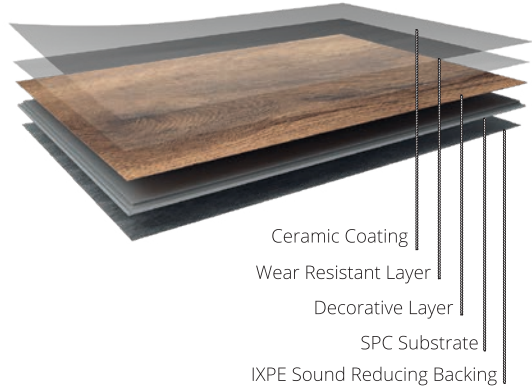

This product may be floated over radiant heat.

*Also available in 6mm format (22 mil wear layer) by special order. Contact a Kährs rep for more information.

Length	Width	Thickness	Pcs/Ctn	SF/Ctn
47 5/8"	6 3/4"	5mm	10	22.39





KÄHRS LUXURY TILES 5MM CLICK | WOOD DESIGN

SAXON CLW 172

LTCLW2109-172

- Design:** Wood Look Plank
- Surface Treatment:** Ceramic Coating
- Wear Layer:** 12 mil*
- Joint:** 5G Click
- Guarantee:** 5 Year Commercial
25 Year Residential
- Installation:** Float

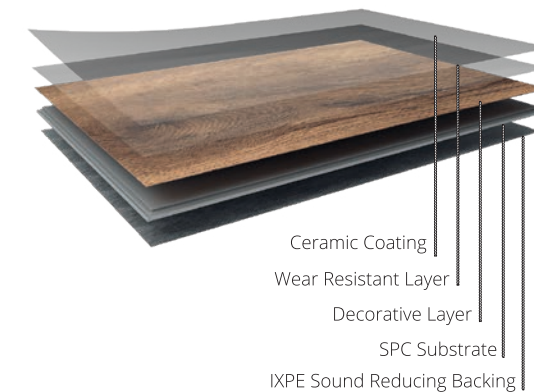

This product may be floated over radiant heat.

*Also available in 6mm format (22 mil wear layer) by special order. Contact a Kährs rep for more information.

Length	Width	Thickness	Pcs/Ctn	SF/Ctn
47 5/8"	6 3/4"	5mm	10	22.39





KÄHRS LUXURY TILES 5MM CLICK | WOOD DESIGN

OULANKA CLW 172

LTCLW2110-172

- Design:** Wood Look Plank
- Surface Treatment:** Ceramic Coating
- Wear Layer:** 12 mil*
- Joint:** 5G Click
- Guarantee:** 5 Year Commercial
25 Year Residential
- Installation:** Float

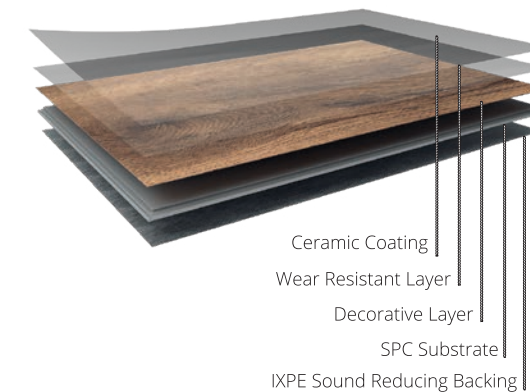

This product may be floated over radiant heat.

*Also available in 6mm format (22 mil wear layer) by special order. Contact a Kährs rep for more information.

Length	Width	Thickness	Pcs/Ctn	SF/Ctn
47 5/8"	6 3/4"	5mm	10	22.39





KÄHRS LUXURY TILES 5MM CLICK | WOOD DESIGN

BELLUNO CLW 172

LTCLW2111-172

- Design:** Wood Look Plank
- Surface Treatment:** Ceramic Coating
- Wear Layer:** 12 mil*
- Joint:** 5G Click
- Guarantee:** 5 Year Commercial
25 Year Residential
- Installation:** Float

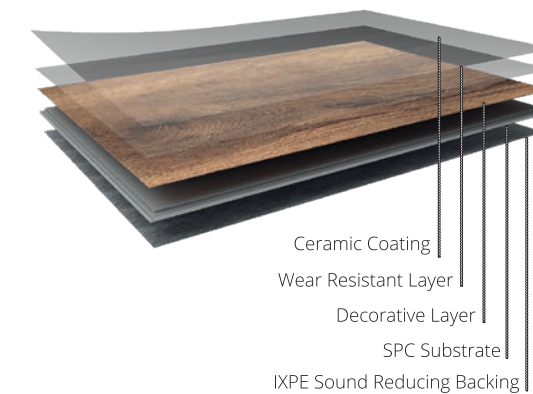

This product may be floated over radiant heat.

*Also available in 6mm format (22 mil wear layer) by special order. Contact a Kährs rep for more information.

Length	Width	Thickness	Pcs/Ctn	SF/Ctn
47 5/8"	6 3/4"	5mm	10	22.39





KÄHRS LUXURY TILES 5MM CLICK | WOOD DESIGN

KANNUR CLW 172

LTCLW2113-172

- Design:** Wood Look Plank, Saw Marks
- Surface Treatment:** Ceramic Coating
- Wear Layer:** 12 mil*
- Joint:** 5G Click
- Guarantee:** 5 Year Commercial
25 Year Residential
- Installation:** Float

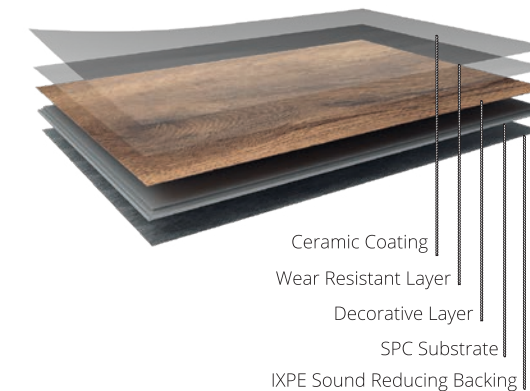

This product may be floated over radiant heat.

*Also available in 6mm format (22 mil wear layer) by special order. Contact a Kährs rep for more information.

Length	Width	Thickness	Pcs/Ctn	SF/Ctn
47 5/8"	6 3/4"	5mm	10	22.39





KÄHRS LUXURY TILES 5MM CLICK | WOOD DESIGN

NIAGARA CLW 172

LTCLW2114-172

- Design:** Wood Look Plank
- Surface Treatment:** Ceramic Coating
- Wear Layer:** 12 mil*
- Joint:** 5G Click
- Guarantee:** 5 Year Commercial
25 Year Residential
- Installation:** Float

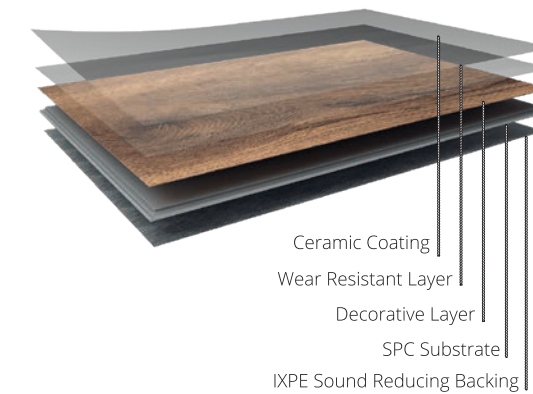

This product may be floated over radiant heat.

*Also available in 6mm format (22 mil wear layer) by special order. Contact a Kährs rep for more information.

Length	Width	Thickness	Pcs/Ctn	SF/Ctn
47 5/8"	6 3/4"	5mm	10	22.39





- Design:** Wood Look Plank
- Surface Treatment:** Ceramic Coating
- Wear Layer:** 12 mil*
- Joint:** 5G Click
- Guarantee:** 5 Year Commercial
25 Year Residential
- Installation:** Float

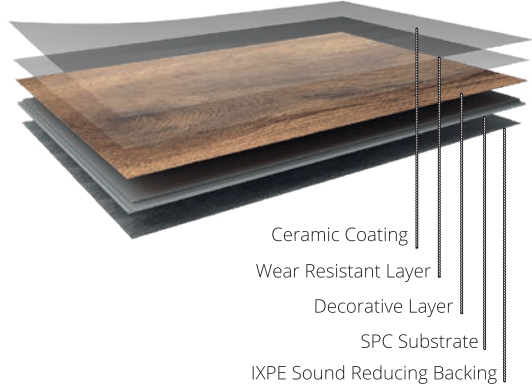

This product may be floated over radiant heat.

*Also available in 6mm format (22 mil wear layer) by special order. Contact a Kährs rep for more information.

Length	Width	Thickness	Pcs/Ctn	SF/Ctn
47 5/8"	6 3/4"	5mm	10	22.39



- Design:** Wood Look Plank
- Surface Treatment:** Ceramic Coating
- Wear Layer:** 12 mil*
- Joint:** 5G Click
- Guarantee:** 5 Year Commercial
25 Year Residential
- Installation:** Float

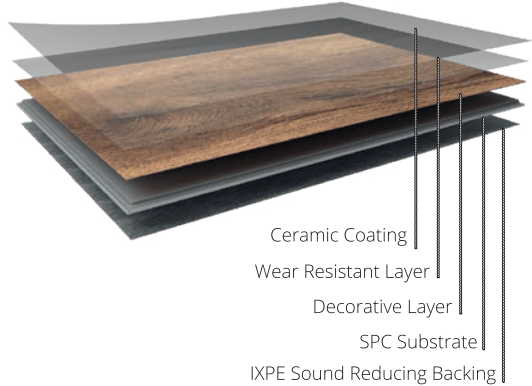

This product may be floated over radiant heat.

*Also available in 6mm format (22 mil wear layer) by special order. Contact a Kährs rep for more information.

Length	Width	Thickness	Pcs/Ctn	SF/Ctn
47 5/8"	6 3/4"	5mm	10	22.39



- Design:** Stone Look
- Surface Treatment:** Ceramic Coating
- Wear Layer:** 12 mil*
- Joint:** 5G Click
- Guarantee:** 5 Year Commercial
25 Year Residential
- Installation:** Float

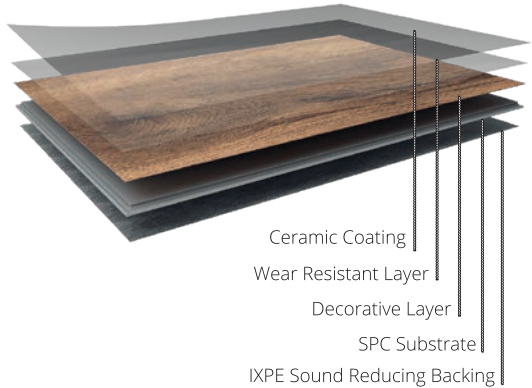

This product may be floated over radiant heat.

*Also available in 6mm format (22 mil wear layer) by special order. Contact a Kährs rep for more information.

Length	Width	Thickness	Pcs/Ctn	SF/Ctn
23 5/8"	11 3/4"	5mm	12	23.25



- Design:** Stone Look
- Surface Treatment:** Ceramic Coating
- Wear Layer:** 12 mil*
- Joint:** 5G Click
- Guarantee:** 5 Year Commercial
25 Year Residential
- Installation:** Float

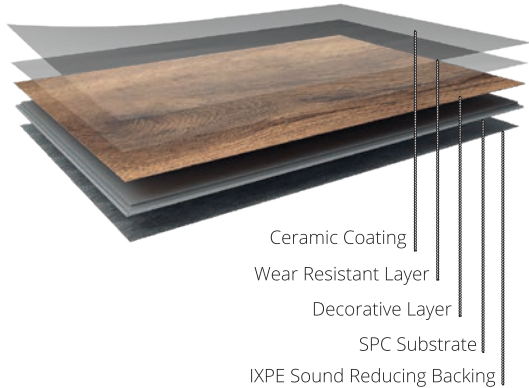

This product may be floated over radiant heat.

*Also available in 6mm format (22 mil wear layer) by special order. Contact a Kährs rep for more information.

Length	Width	Thickness	Pcs/Ctn	SF/Ctn
23 5/8"	11 3/4"	5mm	12	23.25



- Design:** Stone Look
- Surface Treatment:** Ceramic Coating
- Wear Layer:** 12 mil*
- Joint:** 5G Click
- Guarantee:** 5 Year Commercial
25 Year Residential
- Installation:** Float

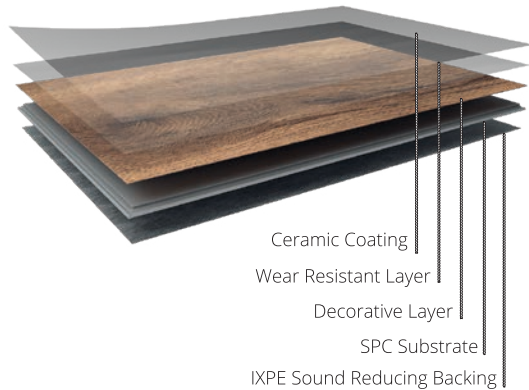

This product may be floated over radiant heat.

*Also available in 6mm format (22 mil wear layer) by special order. Contact a Kährs rep for more information.

Length	Width	Thickness	Pcs/Ctn	SF/Ctn
23 5/8"	11 3/4"	5mm	12	23.25



- Design:** Stone Look
- Surface Treatment:** Ceramic Coating
- Wear Layer:** 12 mil*
- Joint:** 5G Click
- Guarantee:** 5 Year Commercial
25 Year Residential
- Installation:** Float

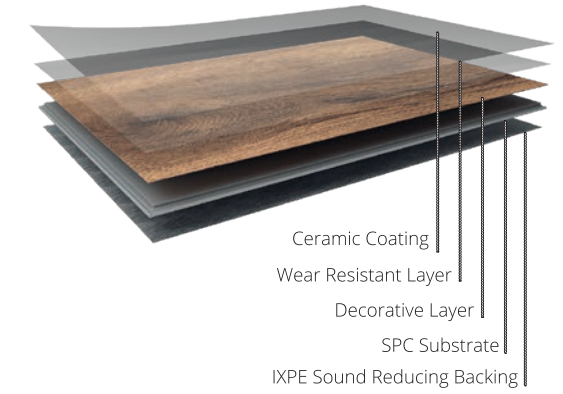

This product may be floated over radiant heat.

*Also available in 6mm format (22 mil wear layer) by special order. Contact a Kährs rep for more information.

Length	Width	Thickness	Pcs/Ctn	SF/Ctn
23 5/8"	11 3/4"	5mm	12	23.25





IMPRESSION COLLECTION



- SOUND REDUCTION 
- WATERPROOF MATERIAL 
- FREE FROM PHTHALATES 
- RIGID CORE 
- 5G CLICK TECHNOLOGY 
- CERAMIC COATING 
- UNDERFLOOR HEATING 

ODENWALD

KÄHRS LUXURY TILES IMPRESSION COLLECTION

CLICK 6MM PRODUCTS

Kährs Luxury Tiles are designed for everyday life. These LVT floors are waterproof, phthalate-free, and durable, made for families, dogs, dirty shoes, and high heels. With a click locking system, sound-reducing backing, and ceramic coating, these Luxury Tiles are easy to install and just as easy to enjoy.

The Impression Collection features extra large formats for extra impressive floors. Plus, thanks to registered embossing, the surface of the floor follows the knots and grain of the pattern image. Created from scans of real wood and stone specimens, these tiles create a true-to-nature experience.

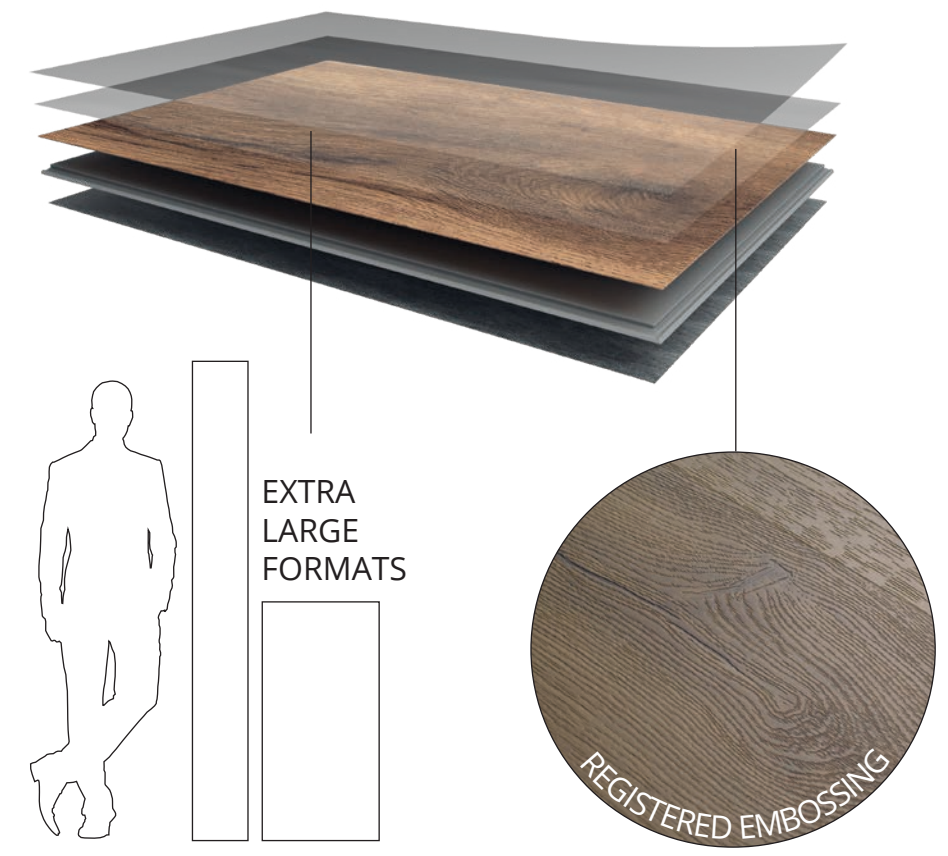



KÄHRS LUXURY TILES 6MM CLICK | WOOD DESIGN

DOVECOT

LTCLW2201-218

- Design:** Wood Look Plank
- Surface Treatment:** Ceramic Coating
- Wear Layer:** 22 mil
- Joint:** 5G Click
- Guarantee:** 5 Year Commercial
25 Year Residential
- Installation:** Float

This product may be floated over radiant heat.

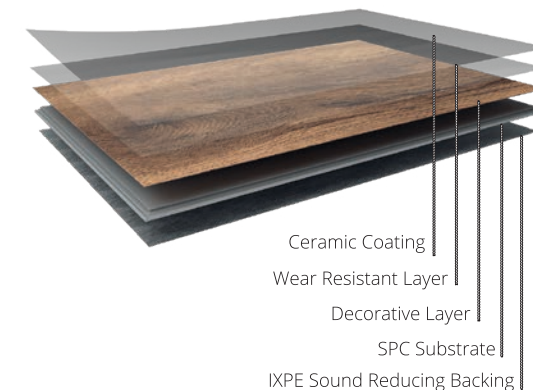

Length	Width	Thickness	Pcs/Ctn	SF/Ctn	Ctn/Pallet	Pallets/Cont.
72"	8 5/8"	6mm	4	17.33	40	21



- Design:** Wood Look Plank
- Surface Treatment:** Ceramic Coating
- Wear Layer:** 22 mil
- Joint:** 5G Click
- Guarantee:** 5 Year Commercial
25 Year Residential
- Installation:** Float

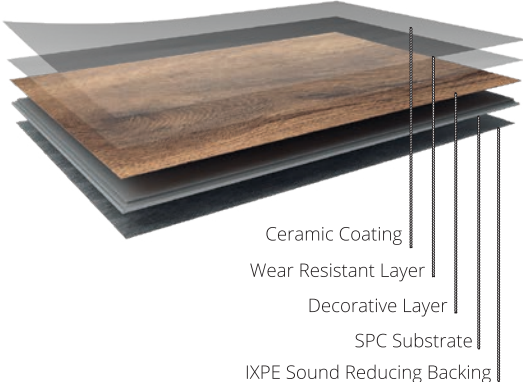

This product may be floated over radiant heat.

Length	Width	Thickness	Pcs/Ctn	SF/Ctn	Ctn/Pallet	Pallets/Cont.
72"	8 5/8"	6mm	4	17.33	40	21





KÄHRS LUXURY TILES 6MM CLICK | WOOD DESIGN

BALMORAL

LTCLW2203-218

- Design:** Wood Look Plank
- Surface Treatment:** Ceramic Coating
- Wear Layer:** 22 mil
- Joint:** 5G Click
- Guarantee:** 5 Year Commercial
25 Year Residential
- Installation:** Float

This product may be floated over radiant heat.

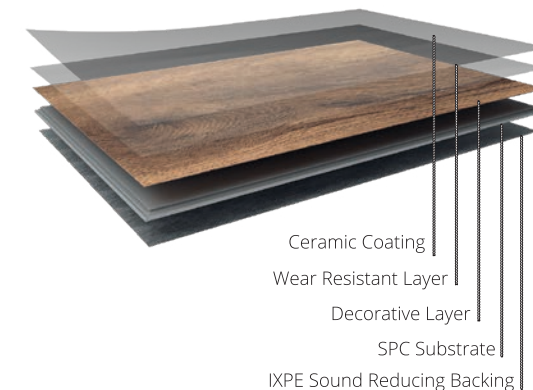

Length	Width	Thickness	Pcs/Ctn	SF/Ctn	Ctn/Pallet	Pallets/Cont.
72"	8 5/8"	6mm	4	17.33	40	21





KÄHRS LUXURY TILES 6MM CLICK | WOOD DESIGN

FOXALL

LTCLW2204-218

- Design:** Wood Look Plank
- Surface Treatment:** Ceramic Coating
- Wear Layer:** 22 mil
- Joint:** 5G Click
- Guarantee:** 5 Year Commercial
25 Year Residential
- Installation:** Float

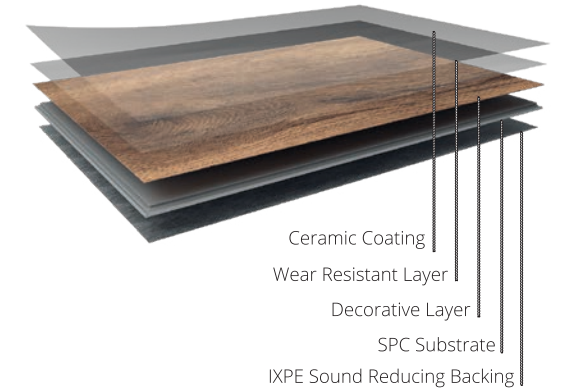

This product may be floated over radiant heat.

Length	Width	Thickness	Pcs/Ctn	SF/Ctn	Ctn/Pallet	Pallets/Cont.
72"	8 5/8"	6mm	4	17.33	40	21





KÄHRS LUXURY TILES 6MM CLICK | WOOD DESIGN

SAHAM

LTCLW2205-218

- Design:** Wood Look Plank
- Surface Treatment:** Ceramic Coating
- Wear Layer:** 22 mil
- Joint:** 5G Click
- Guarantee:** 5 Year Commercial
25 Year Residential
- Installation:** Float

This product may be floated over radiant heat.

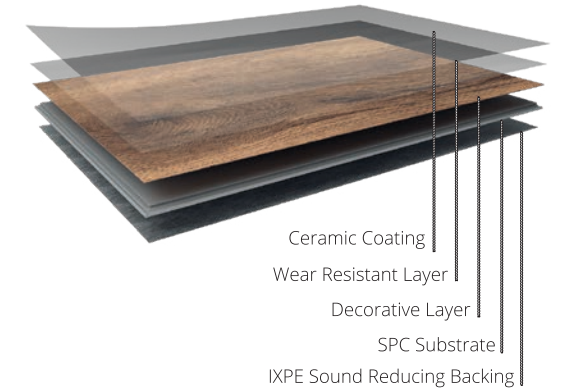

Length	Width	Thickness	Pcs/Ctn	SF/Ctn	Ctn/Pallet	Pallets/Cont.
72"	8 5/8"	6mm	4	17.33	40	21





KÄHRS LUXURY TILES 6MM CLICK | WOOD DESIGN

KELHAM

LTCLW2206-218

- Design:** Wood Look Plank
- Surface Treatment:** Ceramic Coating
- Wear Layer:** 22 mil
- Joint:** 5G Click
- Guarantee:** 5 Year Commercial
25 Year Residential
- Installation:** Float

This product may be floated over radiant heat.

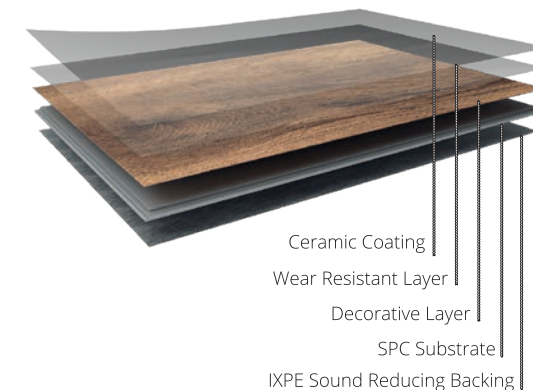

Length	Width	Thickness	Pcs/Ctn	SF/Ctn	Ctn/Pallet	Pallets/Cont.
72"	8 5/8"	6mm	4	17.33	40	21





- Design:** Wood Look Plank
- Surface Treatment:** Ceramic Coating
- Wear Layer:** 22 mil
- Joint:** 5G Click
- Guarantee:** 5 Year Commercial
25 Year Residential
- Installation:** Float

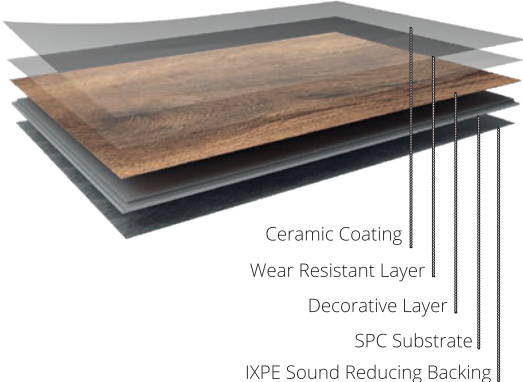

This product may be floated over radiant heat.

Length	Width	Thickness	Pcs/Ctn	SF/Ctn	Ctn/Pallet	Pallets/Cont.
72"	8 5/8"	6mm	4	17.33	40	21



- Design:** Wood Look Plank
- Surface Treatment:** Ceramic Coating
- Wear Layer:** 22 mil
- Joint:** 5G Click
- Guarantee:** 5 Year Commercial
25 Year Residential
- Installation:** Float

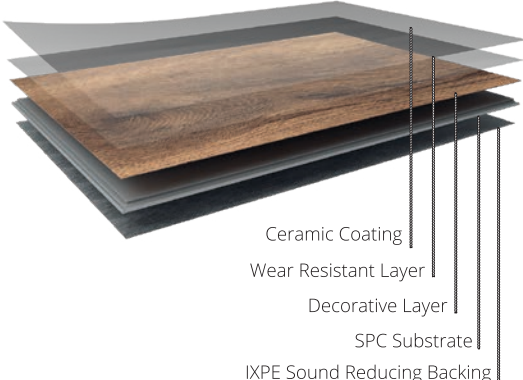

This product may be floated over radiant heat.

Length	Width	Thickness	Pcs/Ctn	SF/Ctn	Ctn/Pallet	Pallets/Cont.
72"	8 5/8"	6mm	4	17.33	40	21





KÄHRS LUXURY TILES 6MM CLICK | STONE DESIGN

ULTAR

LTCLS3101-457

- Design:** Stone Look Tile
- Surface Treatment:** Ceramic Coating
- Wear Layer:** 22 mil
- Joint:** 5G Click
- Guarantee:** 5 Year Commercial
25 Year Residential
- Installation:** Float

This product may be floated over radiant heat.

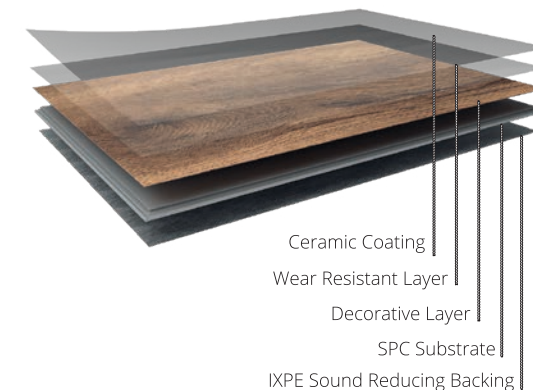

Length	Width	Thickness	Pcs/Ctn	SF/Ctn	Ctn/Pallet	Pallets/Cont.
36"	18"	6mm	10	27	48	24





KÄHRS LUXURY TILES 6MM CLICK | STONE DESIGN

TALUNG

LTCLS3102-457

- Design:** Stone Look Tile
- Surface Treatment:** Ceramic Coating
- Wear Layer:** 22 mil
- Joint:** 5G Click
- Guarantee:** 5 Year Commercial
25 Year Residential
- Installation:** Float

This product may be floated over radiant heat.

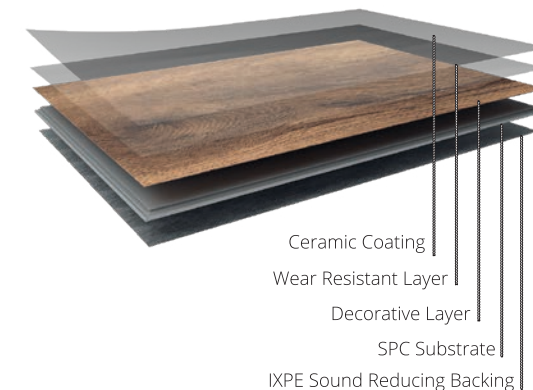

Length	Width	Thickness	Pcs/Ctn	SF/Ctn	Ctn/Pallet	Pallets/Cont.
36"	18"	6mm	10	27	48	24

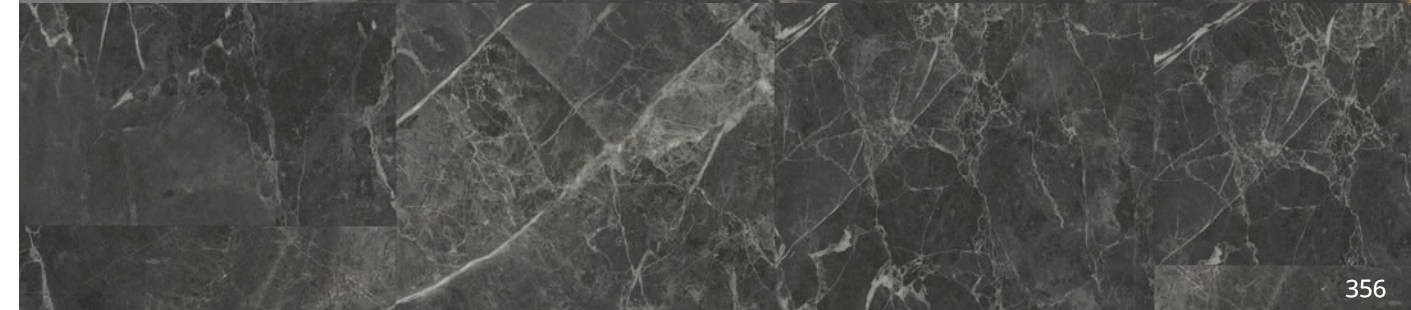



KÄHRS LUXURY TILES 6MM CLICK | STONE DESIGN

ATHOS

LTCLS3103-457

- Design:** Stone Look Tile
- Surface Treatment:** Ceramic Coating
- Wear Layer:** 22 mil
- Joint:** 5G Click
- Guarantee:** 5 Year Commercial
25 Year Residential
- Installation:** Float

This product may be floated over radiant heat.

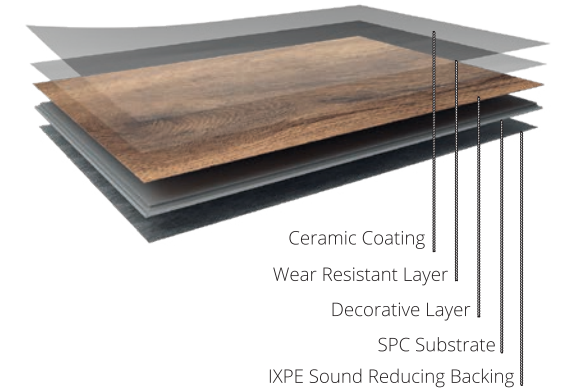

Length	Width	Thickness	Pcs/Ctn	SF/Ctn	Ctn/Pallet	Pallets/Cont.
36"	18"	6mm	10	27	48	24





KÄHRS LUXURY TILES 6MM CLICK | STONE DESIGN

OLYMPUS

LTCLS3104-457

- Design:** Stone Look Tile
- Surface Treatment:** Ceramic Coating
- Wear Layer:** 22 mil
- Joint:** 5G Click
- Guarantee:** 5 Year Commercial
25 Year Residential
- Installation:** Float

This product may be floated over radiant heat.

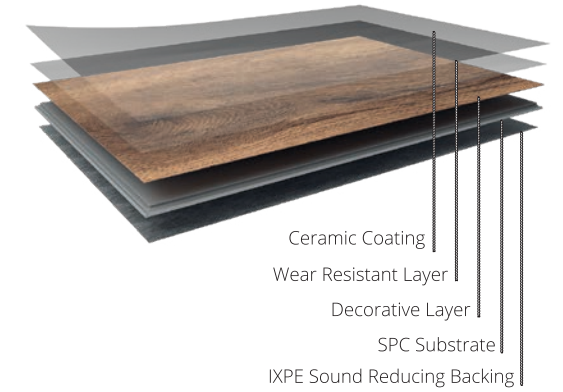

Length	Width	Thickness	Pcs/Ctn	SF/Ctn	Ctn/Pallet	Pallets/Cont.
36"	18"	6mm	10	27	48	24





KÄHRS LUXURY TILES 6MM CLICK | STONE DESIGN

AMARO

LTCLS3105-457

- Design:** Stone Look Tile
- Surface Treatment:** Ceramic Coating
- Wear Layer:** 22 mil
- Joint:** 5G Click
- Guarantee:** 5 Year Commercial
25 Year Residential
- Installation:** Float

This product may be floated over radiant heat.

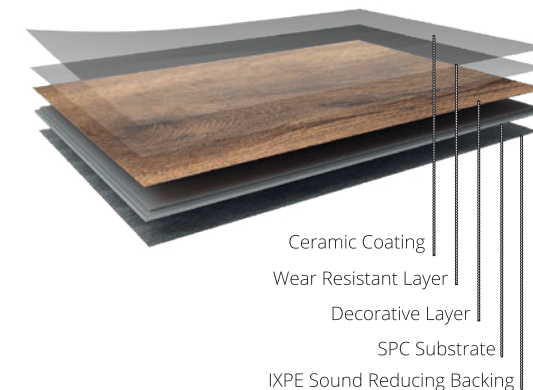

Length	Width	Thickness	Pcs/Ctn	SF/Ctn	Ctn/Pallet	Pallets/Cont.
36"	18"	6mm	10	27	48	24



- Design:** Stone Look Tile
- Surface Treatment:** Ceramic Coating
- Wear Layer:** 22 mil
- Joint:** 5G Click
- Guarantee:** 5 Year Commercial
25 Year Residential
- Installation:** Float

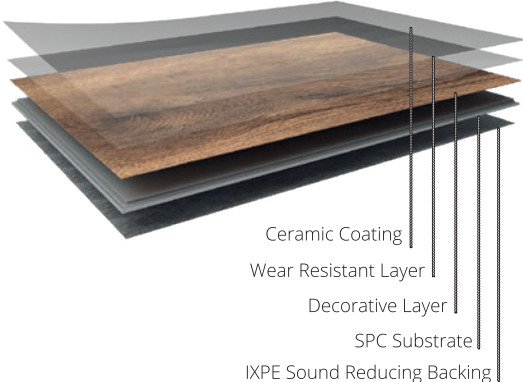

This product may be floated over radiant heat.

Length	Width	Thickness	Pcs/Ctn	SF/Ctn	Ctn/Pallet	Pallets/Cont.
36"	18"	6mm	10	27	48	24



- Design:** Stone Look Tile
- Surface Treatment:** Ceramic Coating
- Wear Layer:** 22 mil
- Joint:** 5G Click
- Guarantee:** 5 Year Commercial
25 Year Residential
- Installation:** Float

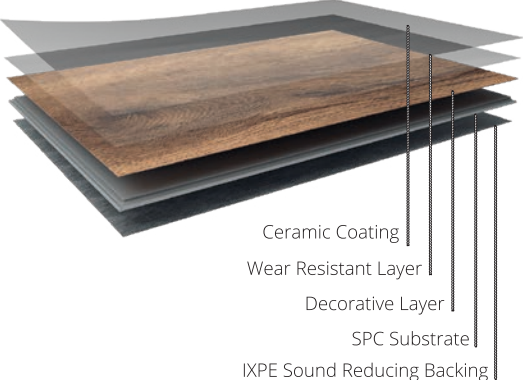

This product may be floated over radiant heat.

Length	Width	Thickness	Pcs/Ctn	SF/Ctn	Ctn/Pallet	Pallets/Cont.
36"	18"	6mm	10	27	48	24



- Design:** Stone Look Tile
- Surface Treatment:** Ceramic Coating
- Wear Layer:** 22 mil
- Joint:** 5G Click
- Guarantee:** 5 Year Commercial
25 Year Residential
- Installation:** Float

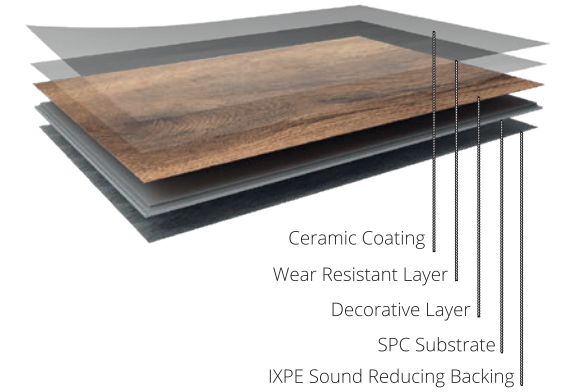

This product may be floated over radiant heat.

Length	Width	Thickness	Pcs/Ctn	SF/Ctn	Ctn/Pallet	Pallets/Cont.
36"	18"	6mm	10	27	48	24





KÄHRS COMPLETE FLOORING SYSTEM FOR LUXURY TILES FLOORING

Kährs offers coordinating accessories for the Luxury Tiles range, so that your new floor will be complete with all the necessary moldings and transitions. Our Luxury Tiles accessories are made of wood and stained to match the product.



For maintenance, Kährs Floor Cleaner can also be used for the Kährs LT Products.

Kährs Floor Cleaner

750 ml bottle Kährs Floor Cleaner
710804

Please email info@kahrs.com for more information on ordering maintenance products and accessories.

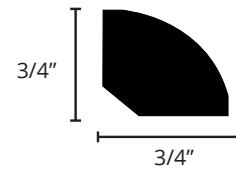

Quarter Round

Conceals expansion space between the wall and Kährs LT flooring. Also used to transition between flooring and cabinetry.

All LT Floors 3/4" x 3/4" x 78" 10lbs 10 pieces

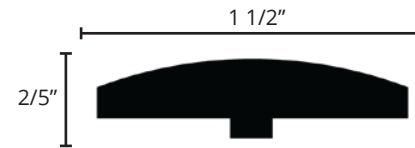

T-Molding

Used in doorways to blend flooring surfaces in adjoining rooms or where floors of the same thickness meet

All LT Floors 1 1/2" X 2/5" X 78" 10lbs 5 pieces

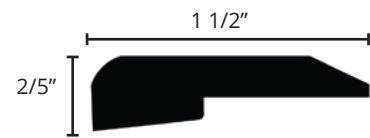

Threshold

Ideal for doorways or to transition between floors of different heights. Used with wood, tile or carpet.

All LT Floors 1 1/2" X 2/5" X 78" 10lbs 5 pieces

*****Please note that all LT moldings are stained Oak.*****



Reducer Overlap

Used with floating floor applications to provide a smooth transition between floors of different heights.

All LT Floors 1 1/2" x 1/3" x 78" 10lbs 5 pieces

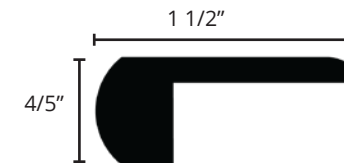

Stair Nose Overlap

Used in stair installations.

All LT Floors 1 1/2" X 4/5" X 78" 20lbs 5 pieces

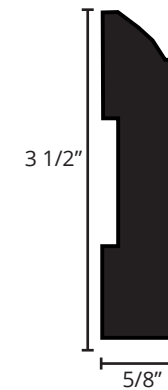

Wall Base

Provides an elegant, traditional transition from the flooring to wall. Gives any room a more formal, finished appearance.

All LT Floors 5/8" x 3 1/2" x 78" 25lbs 5 pieces

*****Please note that all LT moldings are stained Oak.*****

PRODUCT INDEX

A

Alloy, Oak	205
Amaro, LT	361
Aneto, LT	363
Aspeland, Oak	249
Athos, LT	357
Aurora, Oak	163

B

Balmoral, LT	341
Belluno, LT	315
Berlin, Oak	185
Bianco, Oak Palazzo	221
Bisbee, Oak	27
Biscotti, Oak	155
Black, Oak Nouveau	103
Blonde, Oak Nouveau	105
Butterscotch, Oak	13
Bwindi, Aware PVC-Free	281

C

Cadence, Oak	75
Carbon, Oak	67
Ceriale, Ash	35
Chalk, Oak	47
Charcoal Light, Oak	129
Cirrus, Oak	201
Clay, Oak	45
Coast, Oak	165
Cocoa Bean, Oak	19
Coconut Cream, Oak	1
Coral, Ash	53
Crayon, Oak	157
Creme, Oak	197
Curio, Oak	59

D

Dovecot, LT	337
Driftwood, Oak	9
Dublin, Oak	187

E

Dovecot, LT	337
Earl Grey, Oak	11
Eggshell, Oak	153
Etch, Oak	63

F

Faded Black, Oak	15
Fawn, Oak	79
Finnveden, Oak	255
Flow, Ash	161
Foxall, LT	343
Fredrik, Oak	93
Frosted Oak, Oak	131
Frozen Hazelnut, Oak	133
Fumo, Oak Palazzo	217

G

Ghost, Oak	151
Gotha, European Maple	39
Gotland, Ash	237
Grand Canyon, Aware PVC-Free	283
Granite, Oak	199
Gray, Oak Nouveau	101
Greige, Oak Nouveau	107
Grossglockner, LT	365
Gustaf, Oak	89

H

Handbörd, Oak	263
Heather, Oak	83
Henna, Oak	81
Horizon, Oak	167

J

Jasper, Aware PVC-Free	295
------------------------	-----

K

Kannur, LT	317
Kappadokien, Aware PVC-Free	279
Kelham, LT	347
Kilimanjaro, LT	367
Klinta, Oak	265

L

La Paz, Brazilian Cherry	241
Lace, Oak Nouveau	109
Laponia, LT	351
Lava, Oak	203
Lecco, Oak	31
Light Suede, Oak	3
Limestone, Oak	209
Loft White, Oak	125

M

Makalu, LT	329
Matterhorn, LT	325
Montreal, Walnut	231
Möre, Oak	251
Morel, Oak	69
Mostra, Oak	77
Muse, Oak	73

N

Nature, Red Oak	33
Niagara, LT	319

O

Odenwald, LT	349
Olympus, LT	359
Oulanka, LT	313

P

Pale, Oak	207
Paris, Oak	189
Pearl Grey, Oak	123
Pima, Oak	29
Portofino, Oak	211
Prague, Oak	191
Pure Oak	5
Pure Walnut, Oak	17

R

Redwood, LT	305
Reiter, Oak	71
Rise, Oak	169
Rocky, Aware PVC-Free	291
Rovere, Oak Palazzo	219

S

Saham, LT	345
Sand, Oak	49
Sarek, LT	323
Savannah, Cherry	229
Saxon, LT	311
Schwarzhorn, LT	331
Schwarzwald, LT	309
Seed, Oak	51
Serengeti, Aware PVC-Free	287
Sevede, Oak	261
Shore, Oak	171
Siena, Oak	233
Sky, Oak	173
Smoky, Aware PVC-Free	293
Snow, Oak Nouveau	111
Spreewald, LT	339
Steele, LT	327
Stream, Ash	179
Sture, Oak	91
Sun, Oak	175
Supai, Oak	25

T

Taiga, LT	321
Talung, LT	355
Tapa, Oak	65
Taupe, Oak Nouveau	113
Terra, Oak	177
Texture Grau, Oak	139
Texture Natur, Oak	141
Texture Rohoptic, Oak	143
Texture Weiss, Oak	145
Toronto, Hard Maple	227
Tuft, Oak	61
Tveta, Oak	259

U

Ulf, Oak	95
Ultar, LT	353
Urban Brown, Oak	127

V

Vaila, Ash	37
Vedbo, Oak	253
Verona, Oak	235
Viborg, Beech	239
Vista, Oak	247

W

Wentwood, LT	303
Whinell, LT	301
Whisper, Oak Nouveau	115
White, Oak Nouveau	117
Whole Grain, Oak	7

Y

Ydre, Oak	257
Yellowstone, Aware PVC-Free	289
Yosemite, Aware PVC-Free	285
Yukon, LT	307



WHY KÄHRS?

- SWEDISH QUALITY SINCE 1857
- NO ACCLIMATION NEEDED / NO PRE-DELIVERY
- PASSION FOR GREAT DESIGN
- WOODLOC® - NO GAPPING!
- LOWEST CLAIMS IN THE INDUSTRY
- HARMONIOUS ENVIRONMENTAL BALANCE
- SAFE FOR YOU AND YOUR FAMILY
- APPROVED FOR INSTALLATIONS OVER RADIANT HEAT

Kährs

Kährs Headquarters for the Americas
317 Northlake Blvd, Suite 1016
Altamonte Springs, Florida 32701
Tel: +1 800 800 5247 | Fax +1 407 260 9933
info@kahrs.com
www.kahrs.com